



POWER SUPPLY

- AC 100-240V Wide Range Input
- NEC Class 2 Compliant
- Adjustable Output Voltage
- Efficiency up to 89%
- Compact Design, Width only 45mm
- Full Output Power Between -10°C and +60°C
- DC-OK Signal Included
- Large International Approval Package
- DIN-Rail Bracket for Wall or Panel Mount Included
- 3 Year Warranty

1. GENERAL DESCRIPTION

A compact size, light weight, simple mounting on the DIN-rail and the quick connect spring-clamp terminals are what makes the MiniLine power supplies so easy to use and installs in seconds.

A rugged electrical and mechanical design as well as a high immunity against electrical disturbances on the mains provides reliable output power. This offers superior protection for equipment which is connected to the public mains network or is exposed to a critical industrial environment.

The MiniLine series offers output voltages from 5 to 56Vdc and a power rating of up to 100W. A DC-OK signal allows remote diagnostics.

The supplementary MiniLine decoupling diode module MLY02.100 allows building of redundant systems or to protect against back-feed voltages.

24V MiniLine Related products

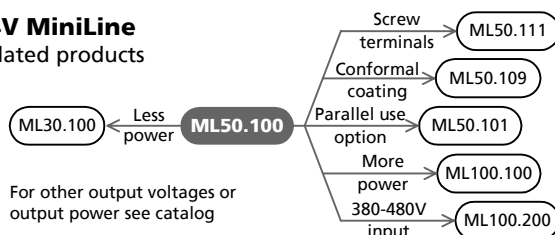

For other output voltages or output power see catalog

2. SHORT-FORM DATA

Output voltage	DC 24V	
Adjustment range	24-28V	
Output current	2.1-1.8A	24-28V
Output power	50W	
Output ripple	< 50mVpp	20Hz to 20MHz
Input voltage	AC 100-240V	Wide Range Input
Mains frequency	50-60Hz	±6%
AC Input current	typ. 0.77 / 0.44A	at 120 / 230Vac
Power factor	typ. 0.56 / 0.52	at 120 / 230Vac
AC Inrush current	17 / 35A	typ. peak value at 120 / 230Vac 40°C and cold start
DC Input	85-375Vdc	
Efficiency	typ. 88.4 / 89.0%	at 120 / 230Vac
Losses	typ. 6.6 / 6.2W	at 120 / 230Vac
Temperature range	-10°C to +70°C	operational
Derating	1.3W/°C	+60 to +70°C
Hold-up time	typ. 35 / 190ms	at 120 / 230Vac
Dimensions	45x75x91mm	WxHxD

3. ORDER NUMBERS

Power Supply	ML50.100	Standard unit
	ML50.109	Conformal coated unit
Accessory	MLY02.100	Decoupling / Redundancy module

4. MARKINGS



INDEX PAGE

1. General Description	1
2. Short-form Data	1
3. Order Numbers	1
4. Markings	1
5. AC-Input	3
6. Input Inrush Current Surge	4
7. DC-Input	4
8. Hold-up Time	5
9. DC-OK Output	5
10. Output	6
11. Efficiency and Power Losses	7
12. Functional Diagram	8
13. Reliability	8
14. Front Side and User Elements	9
15. Terminals and Wiring	9
16. EMC	10
17. Environment	11
18. Protection Features	11
19. Safety	12
20. Dielectric Strength	12

INDEX PAGE

21. Approvals	13
22. Fulfilled Standards	13
23. Used Substances	13
24. Physical Dimensions and Weight	14
25. Installation and Operation Instructions	14
26. Accessory	15
27. Application Notes	16
27.1. Peak Current Capability	16
27.2. Back-feeding Loads	16
27.3. Series Operation	17
27.4. Parallel Use to Increase Output Power ..	17
27.5. Parallel Use for Redundancy	17
27.6. Daisy Chaining of Outputs	18
27.7. Charging of Batteries	18
27.8. External Input Protection	19
27.9. Inductive and Capacitive Loads	19
27.10. Operation on Two Phases	19
27.11. Use in a Tightly Sealed Enclosure	19
27.12. Mounting Orientations	20

INTENDED USE

The power supply shall only be installed and put into operation by qualified personnel.

This power supply is designed for installation in an enclosure and is intended for the general use, such as in industrial control, office, communication, and instrumentation equipment. Do not use this device in aircraft, trains and nuclear equipment, where malfunctioning of the power supply may cause severe personal injury or threaten human life.

TERMINOLOGY AND ABBREVIATIONS

PE and \oplus symbol	PE is the abbreviation for Protective Earth and has the same meaning as the symbol \oplus .
Earth, Ground	This document uses the term "earth" which is the same as the U.S. term "ground".
T.b.d.	To be defined, value or description will follow later.
AC 230V	A figure displayed with the AC or DC before the value represents a nominal voltage with standard tolerances (usually $\pm 15\%$) included. E.g.: DC 12V describes a 12V battery regardless whether it is charged (13.7V) or discharged (10V). As long as not otherwise stated, AC 100V and AC 230V parameters are valid at 50Hz and AC 120V parameters are valid at 60Hz mains frequency.
230Vac	A figure with the unit (Vac) at the end is a momentary figure without any additional tolerances included.

DISCLAIMER

The information presented in this document is believed to be accurate and reliable and may change without notice. The housing is patent by PULS (US patent No US D442,923S)

No part of this document may be reproduced or utilized in any form without permission in writing from the publisher.

5. AC-INPUT

AC input	nom.	AC 100-240V	Wide-range input, TN-, TT-, IT-Mains, see Fig. 5-1
AC input range		85-264Vac 60-85Vac 264-300Vac	Continuous operation Full power for 200ms, no damage between 0 and 85Vac < 0.5s
Input frequency	nom.	50 – 60Hz	±6%
Turn-on voltage	typ.	65Vac	Steady-state value, see Fig. 5-1
Shut-down voltage	typ.	55Vac	Steady-state value, see Fig. 5-1

		AC 100V	AC 120V	AC 230V	
Input current	typ.	0.91A	0.77A	0.47A	at 24V, 2.1A see Fig. 5-3
Power factor *)	typ.	0.58	0.56	0.52	at 24V, 2.1A see Fig. 5-1
Crest factor **)	typ.	3.05	3.26	3.91	at 24V, 2.1A
Start-up delay	typ.	32ms	32ms	32ms	See Fig. 5-2
Rise time	typ.	33ms	33ms	48ms	0mF, 24V, 2.1A, see Fig. 5-2
	typ.	45ms	45ms	60ms	2mF, 24V, 2.1A, see Fig. 5-2
Turn-on overshoot	max.	400mV	400mV	400mV	See Fig. 5-2

*) The power factor is the ratio of the true (or real) power to the apparent power in an AC circuit.

***) The crest factor is the mathematical ratio of the peak value to RMS value of the input current waveform.

Fig. 5-1 Input voltage range

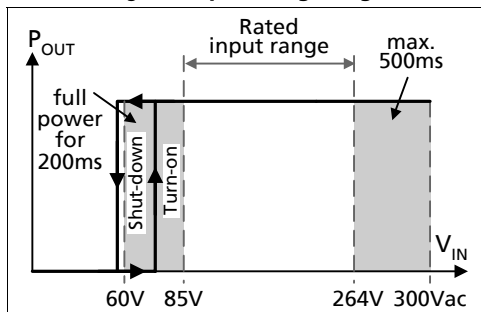

Fig. 5-2 Turn-on behavior, definitions

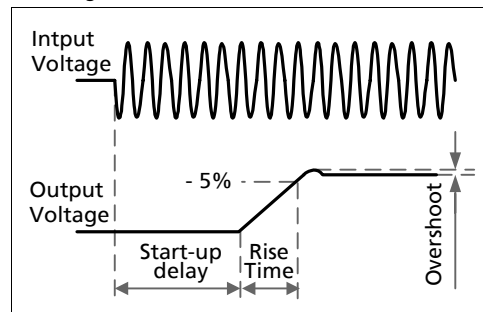

Fig. 5-3 Input current vs. output load

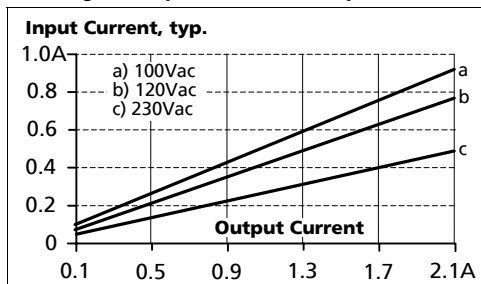
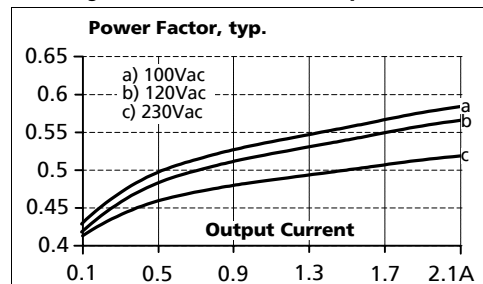

Fig. 5-4 Power Factor vs. output load



6. INPUT INRUSH CURRENT SURGE

A NTC limits the input inrush current after turn-on of the input voltage. The inrush current is input voltage and ambient temperature dependent.

		AC 100V	AC 120V	AC 230V	
Inrush current	max.	18A _{peak}	23A _{peak}	48A _{peak}	40°C ambient, cold start
	typ.	14A _{peak}	17A _{peak}	35A _{peak}	40°C ambient, cold start
Inrush energy	typ.	0.3A ² s	0.4A ² s	1.5A ² s	40°C ambient, cold start

Fig. 6-1 Input inrush current, typical behavior

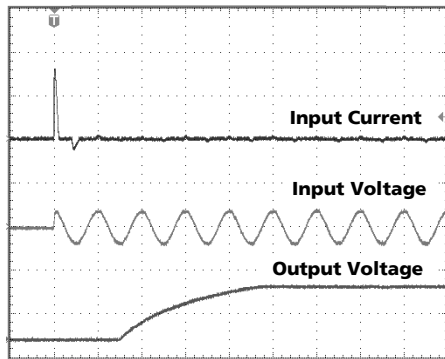

Input: 230Vac
 Output: 24V, 2.1A
 Ambient: 40°C
 Upper curve: Input current 20A / DIV
 Middle curve: Input voltage 1000V / DIV
 Lower curve: Output voltage 20V / DIV
 Time scale: 20ms / DIV

Fig. 6-2 Input inrush current, zoom into the first peak

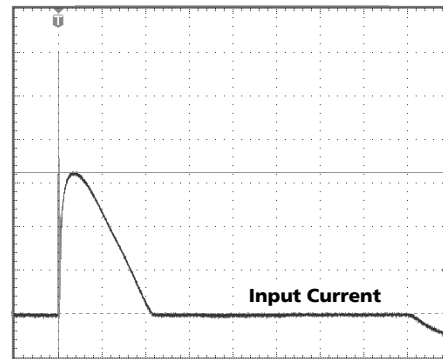

Input: 230Vac
 Output: 24V, 2.1A
 Ambient: 40°C
 Input current curve: 10A / DIV, 1ms / DIV
I_{peak} 32.4A

The charging current into EMI suppression capacitors is disregarded in the first microseconds after switch-on.

7. DC-INPUT

DC input	nom.	DC 110-290V	-25%/+30%
DC input range	min.	85-375Vdc	Continuous operation
DC input current	typ.	0.50A / 0.19A	110Vdc / 300Vdc at 24V and 2.1A
Turn-on voltage	typ.	81Vdc	Steady state value
Shut-down voltage	typ.	58Vdc	Steady state value

Fig. 7-1 Wiring for DC Input

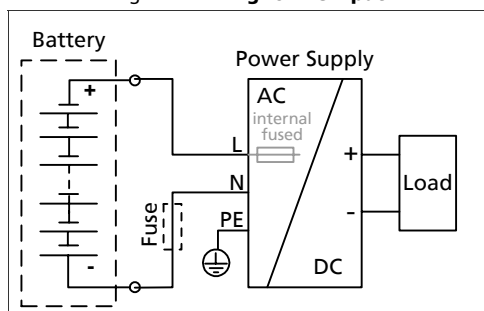

Instructions for DC use:

- Use a battery or similar DC source.
- Connect +pole to L and - pole to N.
- Connect the PE terminal to a earth wire or to the machine ground.
- In case the - pole of the battery is not connected to earth, use an appropriate fuse to protect the N terminal.

8. HOLD-UP TIME

		AC 100V	AC 120V	AC 230V	
Hold-up Time	typ.	54ms	82ms	360ms	1.05A, 24V, see Fig. 8-1
	typ.	26ms	40ms	180ms	2.1A, 24V, see Fig. 8-1

Fig. 8-1 Hold-up time vs. input voltage

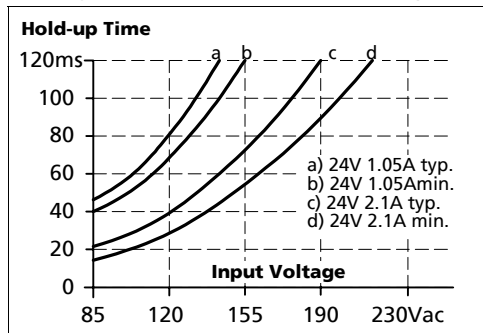
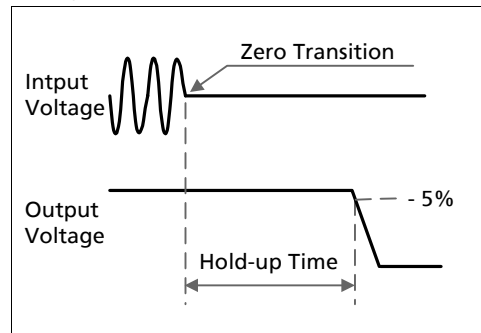

Fig. 8-2 Shut-down behavior, definitions



Note: At no load, the hold-up time can be up to several seconds. The green DC-ok lamp is also on during this time.

9. DC-OK OUTPUT

This feature monitors the output voltage, which is present on the output terminals.

The signal is a source output which can feed loads up to 30mA. Loads can be a 24V relay (Rcoil < 700Ohm), a LED or the input of a PLC system. The relays operates or the LED is on if output voltage exceeds the threshold level. A free-wheeling diode (necessary when the load is a relay) is already included in the power supply.

Threshold value	20V +/-4%		
Output current	min.	30mA	For typical values see Fig. 9-2
Output voltage	min	Vout - 1V at 30mA	The open collector is internally linked to the positive output pole. The DC-OK voltage is approximately the output voltage if the output voltage is higher than the threshold level.

Fig. 9-1 DC-ok wiring diagram

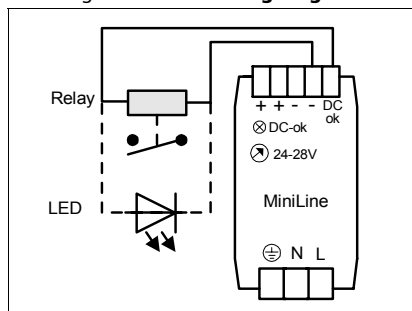
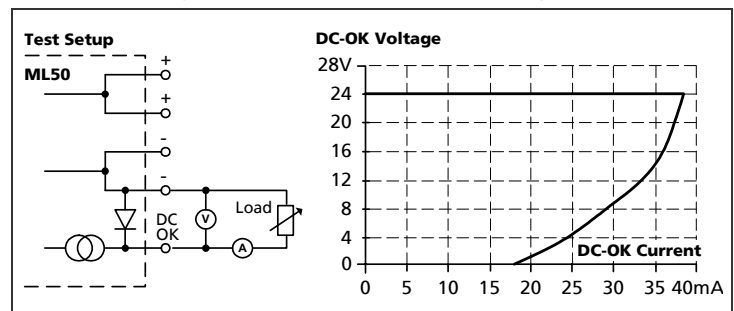

Fig. 9-2 Output characteristic DC-OK signal



10. OUTPUT

Output voltage	nom.	24V	
Adjustment range	min.	24-28V	Guaranteed
	max.	30V	At clockwise end position of potentiometer
Factory setting		24.5V	±0.2%, at full load, cold unit
Line regulation	max.	10mV	85 to 264Vac
Load regulation	max.	100mV	Static value, 0A → 2.1A → 0A
Ripple and noise voltage	max.	50mVpp	20Hz to 20MHz, 50Ohm
Output capacitance	typ.	1600µF	
Output current	nom.	2.1A	At 24V, see Fig. 10-1
	nom.	1.8A	At 28V, see Fig. 10-1
Output power	nom.	50W	
Short-circuit current	min.	3.1A	Load impedance 400mOhm, see Fig. 10-1
	max.	5A	Load impedance 400mOhm, see Fig. 10-1

Fig. 10-1 Output voltage vs. output current, 230Vac, typ.

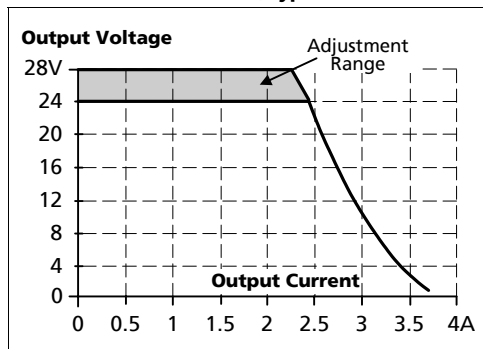

Peak current capability (up to several ms)

The power supply can deliver a peak current which is higher than the specified short term current. This helps to start current demanding loads or to safely operate subsequent circuit breakers.

The extra current is supplied by the output capacitors inside the power supply. During this event, the capacitors will be discharged and cause a voltage dip on the output. Detailed curves can be found in chapter 27.1.

Peak current voltage dips	typ.	from 24V to 16V	at 4.2A for 50ms, resistive load
	typ.	from 24V to 15V	at 10.5A for 2ms, resistive load
	typ.	from 24V to 10.5V	at 10.5A for 5ms, resistive load

11. EFFICIENCY AND POWER LOSSES

		AC 100V	AC 120V	AC 230V	
Efficiency	typ.	87.5%	88.4%	89.0%	2.1A, 24V
Power losses	typ.	0.6W	0.7W	1.3W	0A
	typ.	4.0W	4.1W	4.4W	1.05A, 24V
	typ.	7.2W	6.6W	6.2W	2.1A, 24V

Fig. 11-1 Efficiency vs. output current at 24V

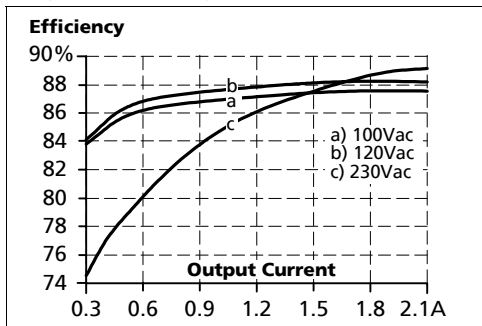

Fig. 11-2 Losses vs. output current at 24V

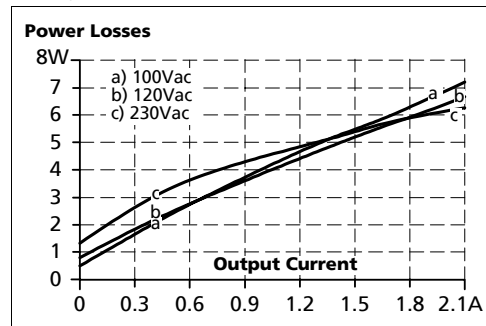

Fig. 11-3 Efficiency vs. input voltage, 24V, 2.1A

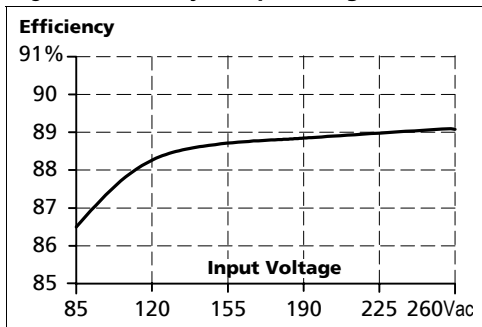
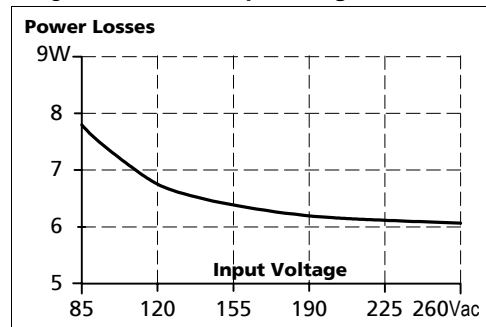

Fig. 11-4 Losses vs. input voltage, 24V, 2.1A



Representante en Perú



MANUFACTURAS ELECTRICAS SA
 Av. O.R. Benavides 1215 – Lima 1
 Tlf: +51-1-6196200
 Email: postmast@manelsa.com.pe
www.manelsa.com.pe

12. FUNCTIONAL DIAGRAM

Fig. 12-1 Functional diagram

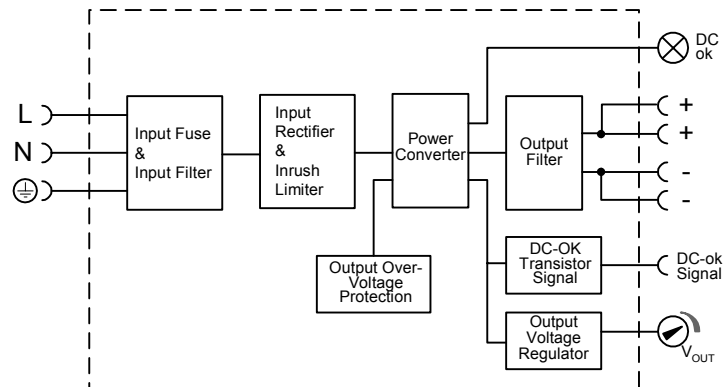

13. RELIABILITY

These units are extremely reliable and use only the highest quality materials. The number of critical components such as electrolytic capacitors has been reduced.

		AC 100V	AC 120V	AC 230V	
Lifetime expectancy	min.	34 000h	44 000h	54 000h	40°C, 24V, 2.1A
	min.	112 000h	117 000h	111 000h	40°C, 24V, 1.05A
	min.	96 000h	125 000h	152 000h	25°C, 24V, 2.1A
MTBF SN 29500, IEC 61709		2 383 000h	2 456 000h	2 613 000h	40°C, 24V, 2.1A
		3 977 000h	4 100 000h	4 362 000h	25°C, 24V, 2.1A
MTBF MIL HDBK 217F		1 021 000h	1 053 000h	1 120 000h	40°C, 24V, 2.1A, Ground Benign GB40
		1 370 000h	1 413 000h	1 503 000h	25°C, 24V, 2.1A, Ground Benign GB25

The **Lifetime expectancy** shown in the table indicates the operating hours (service life) and is determined by the lifetime expectancy of the built-in electrolytic capacitors.

Lifetime expectancy is specified in operational hours. Lifetime expectancy is calculated according to the capacitor's manufacturer specification. The prediction model allows a calculation of up to 15 years from date of shipment.

MTBF stands for **Mean Time Between Failure**, which is calculated according to statistical device failures, and indicates reliability of a device. It is the statistical representation of the likelihood of a unit to fail and does not necessarily represent the life of a product.

14. FRONT SIDE AND USER ELEMENTS

Fig. 14-1 Front side

DC-OK LED (green)

On when the voltage at the output terminals is > 20 V
DC-OK LED and DC-OK signal functions are synchronized

Output Voltage Potentiometer

Turn to set the output voltage.
Factory set: 24.5V

Input Terminals

Spring-clamp terminals
N ... Neutral input
L ... Line (hot) input
⊕ ... PE (Protective Earth) input

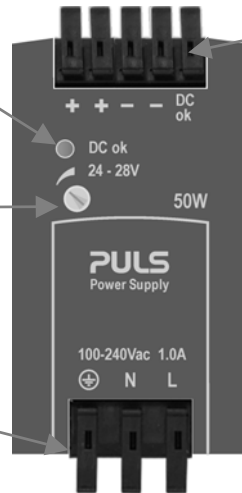

Output & Signal Terminals

Spring-clamp terminals
Dual terminals per pole
+ Positive output
- Negative (return) output
Dual pins per pole
DC-OK Open collector output
Indicates an output voltage higher than 20Vdc

15. TERMINALS AND WIRING

All terminals are easy to access when mounted on the panel. Input and output terminals are separated from each other (input below, output above) to help in error-free wiring. Mounting and wiring do not require any screwdriver.

Type	Quick-connect spring-clamp terminals
Solid wire	0.3-4mm ²
Stranded wire	0.3-2.5mm ²
American wire gauge	26-12 AWG
Ferrules	Allowed, but not required
Wire stripping length	6mm / 0.25inch
Pull-out force	12AWG:60N, 14AWG:50N, 16AWG:40N (according to UL486E)

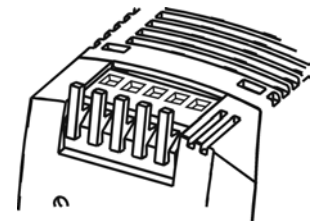
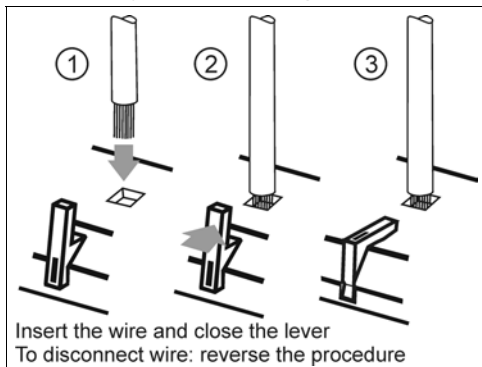

Fig. 15-1 Connecting a wire



Instructions:

- a) Use appropriate copper cables
- b) Follow local and national installation codes and regulations!
- c) Ensure that all strands of a stranded wire enter the terminal connection!
- d) Do not use the unit without PE connection.

16. EMC

The CE mark indicates conformance with EMC guideline 89/336/EEC, 93/68/EEC and the low-voltage directive (LVD) 73/23/EWG. A detailed EMC Report is available on request.

EMC Immunity	EN 61000-6-2, EN 61000-6-1		Generic standards	
Electrostatic discharge	EN 61000-4-2	Contact discharge	8kV	Criterion A
		Air discharge	8kV	Criterion A
Electromagnetic RF field	EN 61000-4-3	80MHz-1GHz	10V/m	Criterion A
Fast transients (Burst)	EN 61000-4-4	Input lines	4kV	Criterion A
		Output lines	2kV	Criterion A
Surge voltage on input	EN 61000-4-5	L → N	2kV	Criterion A
		N / L → PE	4kV	Criterion A
Surge voltage on output	EN 61000-4-5	+ → -	500V	Criterion A
		+ / - → PE	500V	Criterion A
Conducted disturbance	EN 61000-4-6	0,15-80MHz	10V	Criterion A
Mains voltage dips	EN 61000-4-11	0% of 100Vac	0Vac, 20ms	Criterion A
		40% of 100Vac	40Vac, 200ms	Criterion C
		70% of 100Vac	70Vac, 500ms	Criterion A
		0% of 200Vac	0Vac, 20ms	Criterion A
		40% of 200Vac	80Vac, 200ms	Criterion A
70% of 200Vac	140Vac, 500ms	Criterion A		
Voltage interruptions	EN 61000-4-11		0Vac, 5000ms	Criterion C
Input voltage swells	PULS internal standard		300Vac, 500ms	Criterion A
Powerful transients	VDE 0160	over entire load range	750V, 1.3ms	Criterion A

Criteria:

A: Power supply shows normal operation behavior within the defined limits.

C: Temporary loss of function is possible. Power supply might shut-down and restarts by itself. No damages or hazards to the power supply will occur.

EMC Emission	EN 61000-6-3, EN 61000-6-4		Generic standards
Conducted emission	EN 55011, EN 55022, FCC Part 15, CISPR 11, CISPR 22 EN 55022		Class B, input lines
			Class B, output lines
Radiated emission	EN 55011, EN 55022		Class B
Harmonic input current	EN 61000-3-2		Fulfilled
Voltage fluctuations, flicker	EN 61000-3-3		Fulfilled

This device complies with FCC Part 15 rules.

Operation is subjected to the following two conditions: (1) this device may not cause harmful interference, and (2) this device must accept any interference received, including interference that may cause undesired operation.

Switching frequency variable, typ. 100kHz, (60-275kHz) Input voltage and output load dependent

17. ENVIRONMENT

Operational temperature	-10°C to +70°C (14°F to 158°F)	Reduce output power according to Fig. 17-1
Output de-rating	1.3W/°C	60-70°C (140°F to 158°F), see Fig. 17-1
Storage temperature	-40 to +85°C (-40°F to 185°F)	Storage and transportation
Humidity	5 to 95% r.H.	IEC 60068-2-30 Do not energize while condensation is present
Vibration sinusoidal	2-17.8Hz: ±1.6mm; 17.8-500Hz: 2g 2 hours / axis	IEC 60068-2-6
Shock	20g 6ms, 10g 11ms 3 bumps / direction, 18 bumps in total	IEC 60068-2-27
Altitude	0 to 6000m (0 to 20000ft)	Reduce output power or ambient temperature above 2000m sea level.
Output de-rating (for altitude)	3W/1000m or 5°C/1000m	Above 2000m (6500ft), see Fig. 17-2
Over-voltage category	III II	EN 50178, IEC 62103 altitudes < 2000m Altitudes from 2000m to 6000m
Degree of pollution	2	EN 50178, IEC 62103, non conductive

Fig. 17-1 Output current vs. ambient temp.

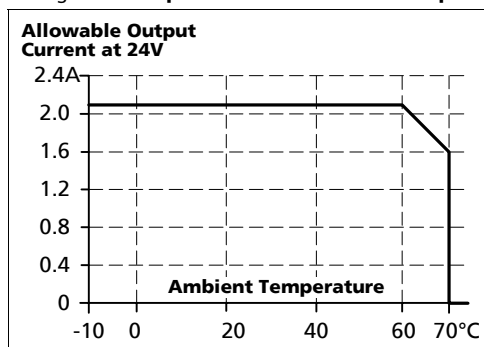

The ambient temperature is defined 2cm below the unit.

Fig. 17-2 Output current vs. altitude, 24V

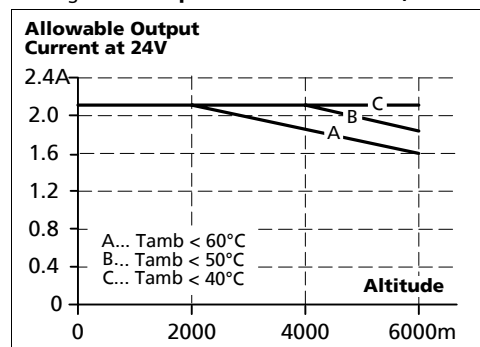

18. PROTECTION FEATURES

Output protection	Electronically protected against overload, no-load and short-circuits	
Output over-voltage protection	typ. 36V max. 39V	In case of an internal power supply fault, a redundant circuit limits the maximum output voltage. The output shuts down and automatically attempts to restart.
Output over-current protection	electronically limited	see Fig. 10-1
Degree of protection	IP 20	EN/IEC 60529
Penetration protection	> 2.5mm in diameter	E.g. screws, small parts
Over-temperature protection	not included	
Input transient protection	MOV	Metal Oxide Varistor
Internal input fuse	T3.15A H.B.C.	Not user replaceable

Note: In case of a over-voltage, overload, no-load or short-circuit event, an audible noise may be heard.

19. SAFETY

Input / output separation	SELV PELV double or reinforced insulation	IEC/EN 60950-1 EN 60204-1, EN 50178, IEC 62103, IEC 60364-4-41
Class of protection	I	PE (Protective Earth) connection required
Isolation resistance	> 5MΩ	input to output, 500Vdc
Touch current (leakage current)	typ. 0.12mA typ. 0.17mA typ. 0.29mA < 0.16mA < 0.23mA < 0.40mA	100Vac, 50Hz, TN mains 120Vac, 60Hz, TN mains 230Vac, 50Hz, TN mains 110Vac, 50Hz, TN mains 132Vac, 60Hz, TN mains 264Vac, 50Hz, TN mains

20. DIELECTRIC STRENGTH

Fig. 20-1 Dielectric strength

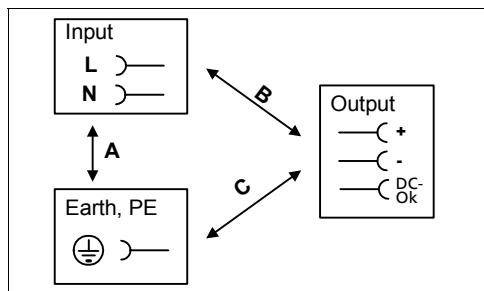

		A	B	C
Type test	60s	2500Vac	3000Vac	500Vac
Factory test	5s	2500Vac	2500Vac	500Vac
Field test	5s	2000Vac	2000Vac	500Vac

Type tests and factory tests:

Conducted by the manufacturer. Do not repeat test in field!







Rules for field test:

Use appropriate test equipment which applies the voltage with a slow ramp! Connect L and N together as well as all output poles.

The output voltage is floating and has no ohmic connection to ground.

To fulfill the PELV requirements according to EN60204-1 § 6.4.1, it is recommended that either the + pole, the - pole or any other part of the output circuit should be connected to the protective earth system. This helps to avoid situations in which a load starts unexpectedly or can not be switched off when an unnoticed earth faults occur.

21. APPROVALS

IEC 60950-1	IECEE CB SCHEME	CB Scheme, Information Technology Equipment
IEC 60601-1	IECEE CB SCHEME	CB Scheme, Medical, Basic Insulation
UL 508		LISTED as Industrial Control Equipment E198865
UL2601		LISTED as Medical
UL 60950-1		RECOGNIZED E137006 recognized for the use in U.S.A. (UL 60950-1) and Canada (C22.2 No. 60950). Information Technology Equipment, Level 3
NEC Class 2		Listed as Limited Power Source (LPS) in the UL 60950-1 UL report.
UL 1604		RECOGNIZED E246877 recognized for use in U.S.A. (UL 1604) and Canada (C22.2 No. 213-M1987) Hazardous Location Class I Div 2 T4 Groups A,B,C,D and Class I Zone 2 Groups IIA, IIB and IIC
<p>The unit is suitable for use in Class I Division 2 Groups A, B, C, D locations as well as for Class I Zone 2 Groups IIA, IIB and IIC locations. Substitution of components may impair suitability for Class I Division 2 environment. Do not disconnect equipment unless power has been switched off. Wiring must be in accordance with Class I, Division 2 wiring methods of the National Electrical Code, NFPA 70, and in accordance with other local or national codes.</p>		
Marine		GL (Germanischer Lloyd) classified and ABS (American Bureau for Shipping) PDA for marine and offshore applications. Environmental category: C, EMC2
SEMI F47		SEMI F47-0200 Power Quality Star Ride-through compliance for semiconductor industry. Full SEMI range compliance (Input: 120Vac or 208Vac)

22. FULFILLED STANDARDS

EN 61558-2-17	Safety of Power Transformers
EN/IEC 60204-1	Safety of Electrical Equipment of Machines
EN/IEC 61131-2	Programmable Controllers
EN 50178, IEC 62103	Electronic Equipment in Power Installations

23. USED SUBSTANCES

Electrolytic capacitors included in this unit do not use electrolytes such as Quaternary Ammonium Salt Systems.
 Plastic housings and other molded plastic materials are free of halogens, wires and cables are not PVC insulated.
 The unit conforms to the RoHS directive 2002/96/EC

The materials used in our production process do not include the following toxic chemicals:
 Polychlorinated Biphenyl (PCB), Pentachlorophenol (PCP), Polychlorinated naphthalene (PCN), Polybrominated Biphenyl (PBB), Polybrominated Biphenyl Oxide (PBO), Polybrominated Diphenyl Ether (PBDE), Polychlorinated Diphenyl Ether (PCDE), Polybrominated Diphenyl Oxide (PBDO), Cadmium, Asbestos, Mercury, Silica

24. PHYSICAL DIMENSIONS AND WEIGHT

Weight	240g / 0.53lb
DIN-Rail	Use 35mm DIN-rails according to EN 60715 or EN 50022 with a height of 7.5 or 15mm. The DIN-rail height must be added to the depth (91mm) to calculate the total required installation depth.

Electronic files with mechanical data can be downloaded at www.pulspower.com

Fig. 24-1 Front view

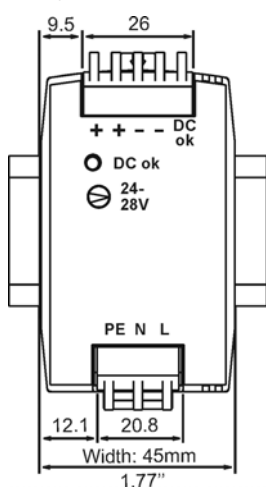
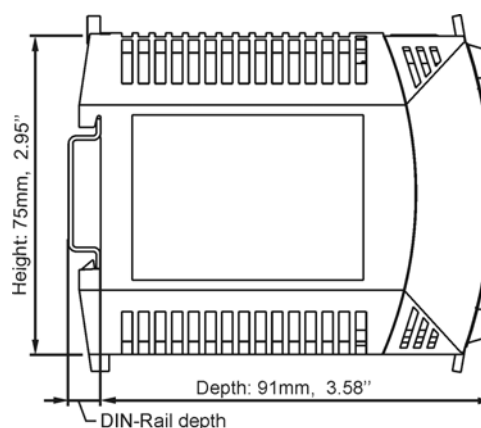

Fig. 24-2 Side view



25. INSTALLATION AND OPERATION INSTRUCTIONS

Mounting:

Output terminal must be located on top and input terminal on the bottom. For other orientations see chapter 27.12. An appropriate electrical and fire end-product enclosure should be considered in the end use application.

Cooling:

Convection cooled, no forced cooling required. Do not cover ventilation grill (e.g. cable conduits) by more than 30%!

Installation clearances:

25mm on top and bottom.

Risk of electrical shock, fire, personal injury or death!

- Do not use the unit without proper earth connection (Protective Earth).
- Turn power off before working on the power supply. Protect against inadvertent re-powering.
- Make sure the wiring is correct by following all local and national codes.
- Do not open, modify or repair the unit.
- Use caution to prevent any foreign objects from entering into the housing.
- Do not use in wet locations or in areas where moisture or condensation can be expected.

Service parts:

The unit does not contain any service parts. The tripping of an internal fuse is caused by an internal fault. If damage or malfunctioning should occur during operation, immediately turn power off and send unit to the factory for inspection!

26. ACCESSORY

DIN-Rail bracket for wall or panel mount

A DIN-rail bracket is included in each shipping box.

Fig. 26-1 **DIN-Rail Bracket**

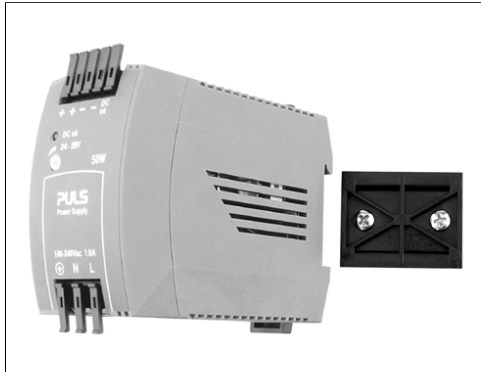
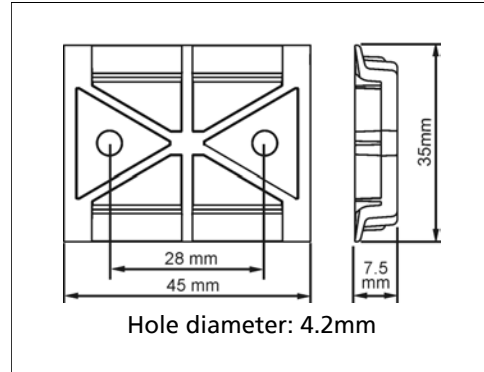

Fig. 26-2 **DIN-Rail Bracket Dimensions**



MLY02.100 Dual decoupling module 2x5A

Fig. 26-3 **MLY02.100 Dual Decoupling Module**

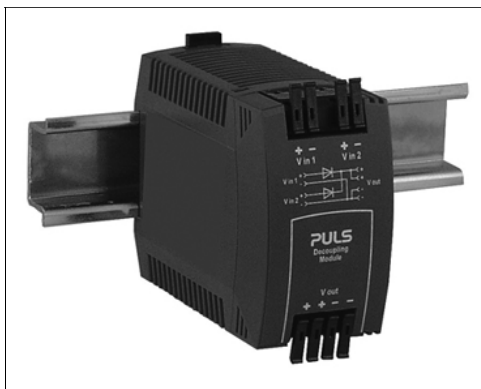
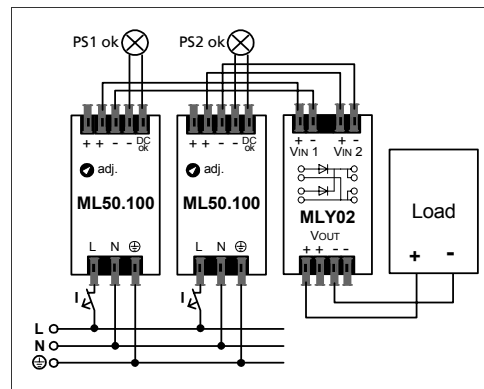

Fig. 26-4 **Redundant System with Two ML50.100 and One MLY02.100**



27. APPLICATION NOTES

27.1. PEAK CURRENT CAPABILITY

Solenoids, contactors and pneumatic modules often have a steady state (sealed) coil and a pick-up coil. The inrush current demand of the pick-up coil is several times higher than the steady state current and usually exceeds the nominal output current. The same situation applies, when starting a capacitive load.

Branch circuits are often protected with circuit breakers or fuses. In case of a short or an overload in the branch circuit, the protective device (fuse, circuit breaker) needs a certain amount of over-current to trip or to blow. The peak current capability ensures the safe operation of subsequent circuit breakers.

Assuming the input voltage is turned on before such an event, the built-in large sized output capacitors inside the power supply can deliver extra current. Discharging this capacitor causes a voltage dip on the output. The following two examples show typical voltage dips:

Fig. 27-1 **Peak load 4.2A for 50ms, typ.**

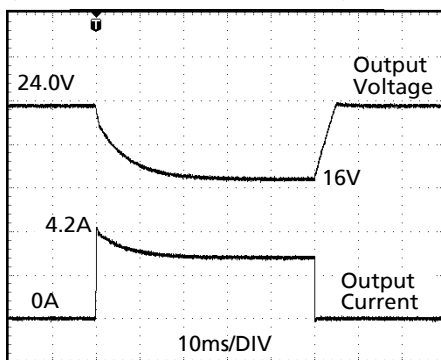

Peak load 4.2A (resistive) for 50ms
Output voltage dips from 24V to 16V.

Fig. 27-2 **Peak load 10.5A for 5ms, typ.**

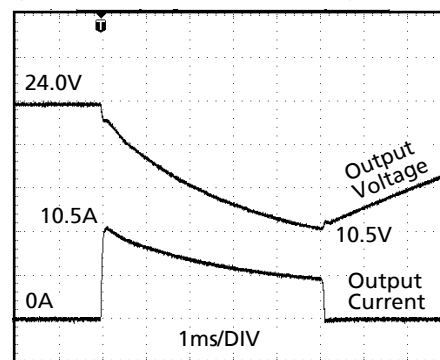

Peak load 10.5A (resistive) for 5ms
Output voltage dips from 24V to 10.5V.

27.2. BACK-FEEDING LOADS

Loads such as decelerating motors and inductors can feed voltage back to the power supply. This feature is also called return voltage immunity or resistance against Back- E.M.F. (Electro Magnetic Force).

This power supply is resistant and does not show malfunctioning when a load feeds back voltage to the power supply. It does not matter, whether the power supply is on or off.

The maximum allowed feed back voltage is 35Vdc. The absorbing energy can be calculated according to the built-in large sized output capacitor which is specified in chapter 10.

27.3. SERIES OPERATION

The power supply can be put in series to increase the output voltage.

Fig. 27-3 Schematic for series operation

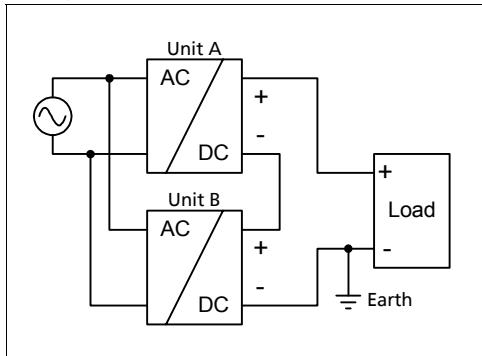

Instructions for use in series:

- It is possible to connect as many units in series as needed, providing the sum of the output voltage does not exceed 150Vdc.
- Voltages with a potential above 60Vdc are not SELV any more and can be dangerous. Such voltages must be installed with a protection against touching.
- For serial operation use power supplies of the same type.
- Earthing of the output is required when the sum of the output voltage is above 60Vdc.

Note: Avoid return voltage (e.g. from a decelerating motor or battery) which is applied to the output terminals.

27.4. PARALLEL USE TO INCREASE OUTPUT POWER

Several power supplies can be paralleled to increase the output power. The ML50.100 has no feature included which balances the load current between the power supplies. Usually the power supply with the higher adjusted output voltage draws current until it goes into current limitation. This means no harm to this power supply as long as the ambient temperature stays below 50°C. If a current sharing feature is required, choose the ML50.101 or ML50.111.

Fig. 27-4 Schematic for parallel operation

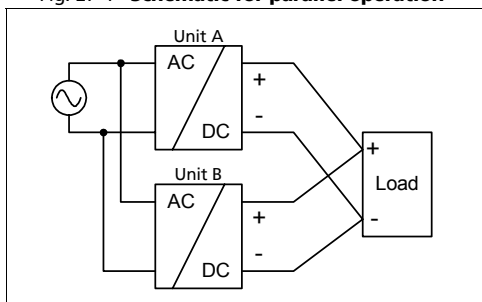

Instructions for parallel use:

- Use only power supplies from the same series (ML-Series).
- Adjust the output voltages of all power supplies to approximately the same value ($\pm 200\text{mV}$).
- A fuse (or diode) on the output is only required if more than three units are connected in parallel.
- Do not load terminals with more than 13A. Follow wiring instructions according to chapter 27.6
- Ensure that the ambient temperature of the power supply does not exceed 50°C.

27.5. PARALLEL USE FOR REDUNDANCY

Power supplies can be paralleled for redundancy to gain a higher system reliability. Redundant systems require a certain amount of extra power to support the load in case one power supply unit fails. The simplest way is to put two MiniLine power supplies in parallel. This is called a 1+1 redundancy. In case one power supply unit fails, the other one is automatically able to support the load current without any interruption. Redundant systems for a higher power demand are usually built in a N+1 method. E.g. Five power supplies, each rated for 2.1A are paralleled to build a 8A redundant system. If one unit fails, the 8A can still be drawn.

Please note: This simple way to build a redundant system has two major disadvantages:

- The faulty power supply can not be recognized. The green LED will still be on since it is reverse-powered from the other power supply.
- It does not cover failures such as an internal short circuit in the secondary side of the power supply. In such a situation the defective unit becomes a load for the other power supplies and the output voltage can not be maintained any more.

This above conditions can be avoided by utilizing decoupling diodes which are included in the decoupling module MLY02.100.

Other recommendations for building redundant power systems:

- a) Use separate input fuses for each power supply.
- b) Monitor the individual power supply units. A DC-ok output is included in the ML50.100, ML50.101 and ML50.111. In all other cases, use the redundancy module YRM2.DIODE which has a monitoring circuit for each input included.
- c) When possible, connect each power supply to different phases of the mains network.

27.6. DAISY CHAINING OF OUTPUTS

Daisy chaining (jumping from one power supply output to the next) is allowed as long as the maximum current through one terminal pin does not exceed 13A. If the current is higher, use a separate distribution terminal block.

Fig. 27-5 Daisy chaining of outputs

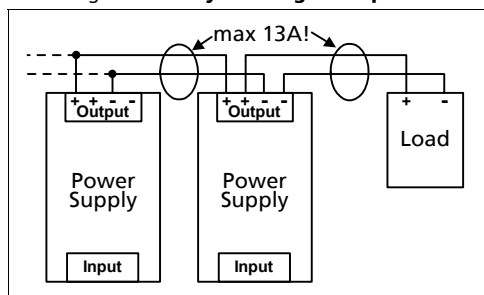
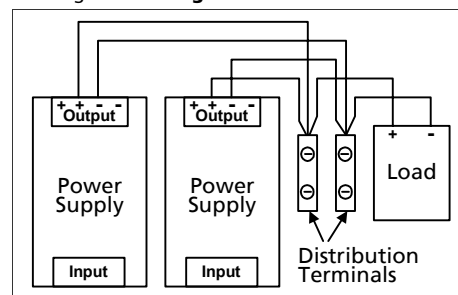

Fig. 27-6 Using distribution terminals



27.7. CHARGING OF BATTERIES

The power supply can be used for float-charging of lead-acid or maintenance free 24V VRLA batteries.

Instructions for charging batteries:

- a) Ensure that the ambient temperature of the power supply does not exceed 50°C.
- b) Set the output voltage on a disconnected load, very precisely to the end-of-charge voltage according to the expected battery temperature.

End-of-charge voltage	27.8V	27.5V	27.15V	26.8V
Battery temperature	10°C	20°C	30°C	40°C

- c) Use a 4A or 6A circuit breaker (or blocking diode) between the power supply and the battery.
- d) Ensure that the output current of the power supply is below the allowed charging current of the battery.
- e) Use only matched batteries when putting 12V types in series.
- f) The return current to the power supply is typ. 10.7mA at 25Vdc when the power supply is switched off (except in case a blocking diode is utilized).

27.8. EXTERNAL INPUT PROTECTION

The unit is tested and approved for branch circuits up to 15A (UL) or 16A (IEC). External protection is only required if the supplying branch has an ampacity greater than this. In some countries local regulations might apply so check local codes and requirements.

If an external protective device is utilized, a minimum value is required to avoid undesired tripping of the fuse.

		B-Characteristic	C-Characteristic
Ampacity	max.	15A (UL), 16A (IEC)	15A (UL), 16A (IEC)
	min.	10A	6A

27.9. INDUCTIVE AND CAPACITIVE LOADS

The unit is designed to supply any type of load, including unlimited capacitive and inductive loads.

27.10. OPERATION ON TWO PHASES

Fig. 27-7 Schematic for two phase operation

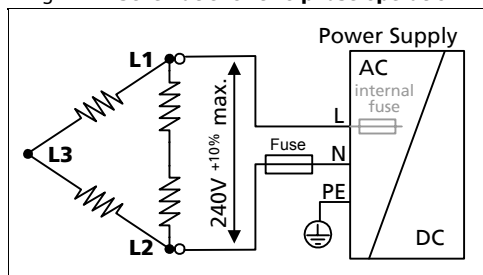

Instructions for two phase operation:

- A phase to phase connection is allowed as long as the supplying voltage is below $240V^{+10\%}$.
- Use a fuse or a circuit breaker to protect the N input. The N input is internally not protected and is in this case connected to a hot wire.

Appropriate fuses or circuit breakers are specified in section 27.6 "External Input Protection".

27.11. USE IN A TIGHTLY SEALED ENCLOSURE

When the power supply is installed in a tightly sealed enclosure, the temperature inside the enclosure will be higher than the outside. The inside temperature defines the ambient temperature for the power supply.

Results from such an installation:

Power supply is placed in the middle of the box, no other heat producing equipment inside the box

Enclosure: Rittal Type IP66 Box PK 9510 100, plastic, 130x130x75mm
 Input: 230Vac

Load: 24V, 2.1A; load is placed outside the box
 Temperature inside the box: 40.8°C (in the middle of the right side of the power supply with a distance of 1cm)
 Temperature outside the box: 21.9°C
 Temperature rise: 18.9K

Load: 24V, 1.7A; (=80%) load is placed outside the box
 Temperature inside the box: 38.7°C (in the middle of the right side of the power supply with a distance of 1cm)
 Temperature outside the box: 21.7°C
 Temperature rise: 17.0K

27.12. MOUNTING ORIENTATIONS

Mounting orientations other than input terminals on the bottom and output on the top requires a reduction in continuous output power or a limitation in the maximum allowed ambient temperature. The amount of reduction influences the lifetime expectancy of the power supply. Therefore, two different derating curves for continuous operation can be found below:

Curve A1 Recommended output power.

Curve A2 Max allowed output power (results approx. in half the lifetime expectancy of A1).

Fig. 27-8

Mounting Orientation A
Standard Orientation

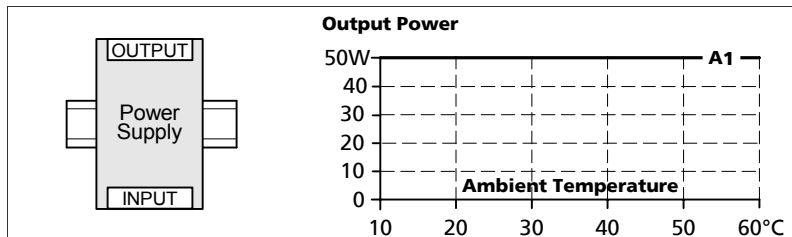

Fig. 27-9

Mounting Orientation B
(Upside down)

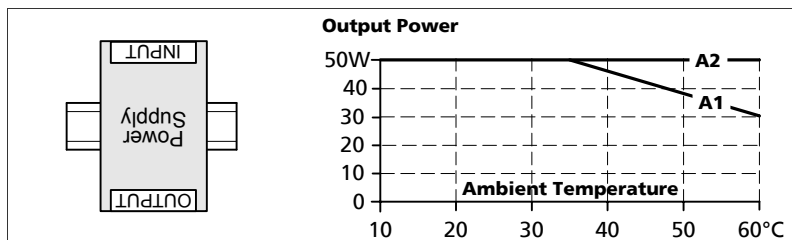

Fig. 27-10

Mounting Orientation C
(Table-top mounting)

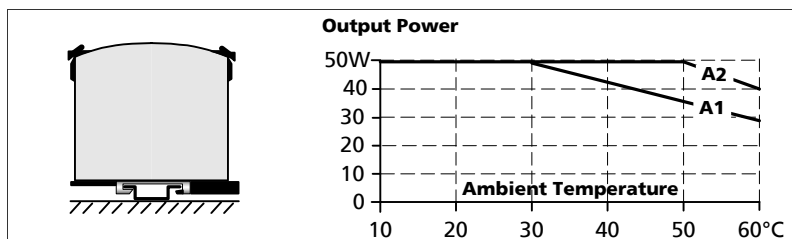

Fig. 27-11

Mounting Orientation D
(Horizontal cw)

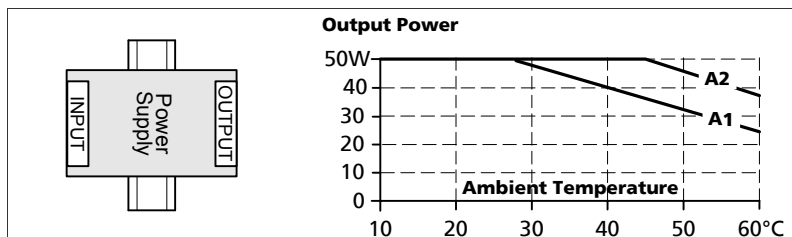

Fig. 27-12

Mounting Orientation E
(Horizontal ccw)

