



Cam switches  
CA Series





## Overview

The range of cam switches **CA series** includes ratings from 12 to 630A and insulation voltages of 690V.

The CA series offers IP00 terminals protection degree (it's possible to increase the protection degree by mounting terminal covers, optionally available) and up to IP66 handle protection degree. Available with different mounting systems: rear and base mounting, both with screws.

Available diagrams for every application: ON-OFF switches, line switches, cam switches for motor control, ammeter and voltmeter switches, multi step switches.

Assembled with metal shaft and threaded stud bolts to ensure maximum operating reliability



■ Class V2 self-extinguishing thermoplastic housing

■ Positive opening double break contacts, silver alloy made.



## Base mounting (12A-40A)

- All base mounting items (BL6 - BK6 handles) include a 175 mm (6.89") shaft.
- Terminals with self raising plate and captive screws for sizes 12 ÷ 20A and 25 ÷ 40A.
- Connection terminals with screws provided with cable clamp for switches up to 100A and with cable coupling for bigger sizes.

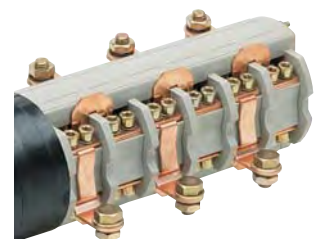

## ■ New compact size

The new release of the CA series has been redesigned to be more compact, while preserving the electrical performances.

| Total length (rear mount)<br>Number of elements | CA012/020           |                      | CA025/040            |                      |
|---|---------------------|----------------------|----------------------|----------------------|
|   | New release         | Old release          | New release          | Old release          |
| 1   | 36,5mm<br>(1,44 in) | 38,0mm<br>(1,50 in)  | 42,5mm<br>(1,68 in)  | 49,5mm<br>(1,94 in)  |
| 2   | 49,0mm<br>(1,93 in) | 51,0mm<br>(2,01 in)  | 59,0mm<br>(2,32 in)  | 65,5mm<br>(2,58 in)  |
| 3   | 61,0mm<br>(2,41 in) | 63,0mm<br>(2,49 in)  | 75,0mm<br>(2,96 in)  | 81,5mm<br>(3,22 in)  |
| 4   | 73,5mm<br>(2,90 in) | 75,5mm<br>(2,97 in)  | 91,5mm<br>(3,60 in)  | 98,0mm<br>(3,86 in)  |
| 5   | 85,5mm<br>(3,37 in) | 87,5mm<br>(3,45 in)  | 107,5mm<br>(4,23 in) | 114,0mm<br>(4,49 in) |
| 6   | 97,5mm<br>(3,85 in) | 100,0mm<br>(3,93 in) | 123,5mm<br>(4,87 in) | 130,5mm<br>(5,13 in) |

A new additional benefit for this new release of the CA series is the improved connection capability of the terminals, that allows to use wires with larger cross-sections and eases the use of ferrules.

Maximum cross-sections are now:

- CA012-020: 4 mm<sup>2</sup> solid and flex wire (AWG 12)
- CA025-040: 10 mm<sup>2</sup> solid and flex wire (AWG 8)



CA012-040

This new release of the CA series allows 2-screw fixing options with two layouts:

- 2 holes at 28mm (1.10") vertical distance
- 2 holes at 32mm (1.26") horizontal distance



## ■ Customized solutions

In our archive are available more than 10,000 diagrams to tailor every customers' needs.

(see page 99)

**Technical data  
IEC 947-3  
EN 60947-3**

|   |      |        | <b>CA012</b> |
|---|------|--------|--------------|
| Rated insulation voltage  | Ui   | V      | 690          |
| Rated operating voltage   | Ue   | V      | 690          |
| Rated impulse withstand voltage   | Uimp | kV     | 6            |
| Rated thermal current for open switch   | Ith  | A      | 16           |
| Rated thermal current for enclosed switch   | Ithe | A      | 16           |
| Rated operation frequency   |      | Hz     | 50           |
| Power dissipation for each pole   |      | W      | 0,27         |
| <b>Rated operating current</b>  |      |        |              |
| AC-21A Switching resistive loads, including moderate overloads                            | Ie   | A      | 12           |
| AC-22A Switching of mixed resistive and inductive loads, including moderate overloads     | Ie   | A      | 12           |
| AC-20A Connecting and disconnecting under no load conditions                              |      |        | -            |
| <b>Rated operating power</b>  |      |        |              |
| AC-23A Switching of motor loads or other highly inductive loads 3 phase - 3 pole          | 230V | Kw (A) | 3 (9)        |
|   | 400V | Kw (A) | 4 (9)        |
|   | 500V | Kw (A) | -            |
|   | 690V | Kw (A) | -            |
| AC-23A Switching of motor loads or other highly inductive loads 1 phase - 2 pole          | 110V | Kw (A) | 0,75 (8,5)   |
|   | 230V | Kw (A) | 1,5 (8,5)    |
| AC-3 Squirrel cage motors: starting, switching off motors during running 3 phase - 3 pole | 230V | Kw (A) | 2,2 (7)      |
|   | 400V | Kw (A) | 3,5 (7)      |
|   | 500V | Kw (A) | -            |
|   | 690V | Kw (A) | -            |
| AC-3 Squirrel cage motors: starting, switching off motors during running 1 phase - 2 pole | 110V | Kw (A) | 0,37 (4)     |
|   | 230V | Kw (A) | 1,1 (6)      |
|   | 400V | Kw (A) | -            |
| AC-4 Squirrel cage motors: starting, plugging, inching                                    | 230V | Kw (A) | -            |
|   | 400V | Kw (A) | -            |
| AC-15 Control of a.c. electromagnetic loads   | 230V | A      | 4            |
|   | 400V | A      | 3            |
| Rated breaking capability in category in AC-23A (cos φ=0,45)                              | 230V | A      | 72           |
|   | 400V | A      | 72           |
| <b>Short circuit protection</b>   |      |        |              |
| Rated short time withstand current  | Icw  | A      | 150          |
| Rated short-circuit make capacity   | Icm  | A      | -            |
| Rated conditional short-circuit current   | -    | kA     | 4            |
| With fuses class gG   | 500V | A      | 16           |

**Technical data  
UL/CSA**

|   |      |          |           |
|---|------|----------|-----------|
| Rated insulation voltage                    | Ui   | UL/CSA V | 600/ -    |
| Rated operating voltage                     | Ue   | UL/CSA V | 600/ -    |
| General Use Current                         | Ie   | UL/CSA A | 12        |
| Short Circuit Rating@600Vac                 |      | Arms     | 5000      |
| Fuse size (Class RK5, 600Vac, 200kA A.I.C.) |      | A        | 60        |
| <b>Rated operating power</b>                |      |          |           |
| 1 phase - 2 pole                            | 120V | Hp (A)   | 0,5 (9,8) |
|   | 240V | Hp (A)   | 1,5 (10)  |
| 3 phase - 3 pole                            | 200V | Hp (A)   | 1,5 (6,9) |
|   | 240V | Hp (A)   | 2 (6,8)   |
|   | 480V | Hp (A)   | 3 (4,8)   |
|   | 600V | Hp (A)   | 5 (6,1)   |

**Mechanical characteristics**

|   |   |                          |                 |         |
|---|---|--------------------------|-----------------|---------|
| Mechanical life   |   | Cycles x 10 <sup>6</sup> | 2               |         |
|   |   | Cicles/hour              | 120             |         |
| <b>Connections according to IEC 9471-1 and EN 60947-1</b> |   |                          |                 |         |
| Connecting capability                                     | Connecting capability with flexible wires | Min-Max                  | mm <sup>2</sup> | 2x1,5-4 |
|   |   | Min-Max                  | AWG             | 16-10   |
|   | Connecting capability with solid wires    | Min-Max                  | mm <sup>2</sup> | 2x1,5-6 |
| Connection terminal screw dimensions                      |   | Type                     | M3,5            |         |
| Screw tightening torque                                   |   | Nm                       | 1,0             |         |
| <b>Protection degree IEC 529 EN 60529</b>                 |   |                          |                 |         |
| Terminals   |   | IP                       |                 |         |
| <b>Ambient conditions</b>                                 |   |                          |                 |         |
| Operating ambient temperature                             |   | °C                       |                 |         |
| Storage ambient temperature                               |   | °C                       |                 |         |
| Withstand to constant humid according to IEC 60068        |   |                          |                 |         |
| Withstand to cyclic humid according to IEC 60068          |   |                          |                 |         |

| CA016     | CA020                         | CA025      | CA032    | CA040     | CA050    | CA063           | CA100                | CA200              | CA400  | CA630                 |
|-----------|-------------------------------|------------|----------|-----------|----------|-----------------|----------------------|--------------------|--|-----------------------|
| 690       | 690                           | 690        | 690      | 690       | 690      | 690             | 690                  | 690                | 690  | 690                   |
| 690       | 690                           | 690        | 690      | 690       | 690      | 690             | 690                  | 690                | 690  | 690                   |
| 6         | 6                             | 6          | 6        | 6         | 6        | 6               | 6                    | 6                  | 6  | 6                     |
| 20        | 25                            | 32         | 32       | 40        | 50       | 75              | 115                  | 200                | 400  | 630                   |
| 20        | 25                            | 32         | 32       | 40        | 50       | 75              | 100                  | 160                | -  | -                     |
| 50        | 50                            | 50         | 50       | 50        | 50       | 50              | 50                   | 50                 | 50   | 50                    |
| 0,5       | 0,4                           | 1,0        | 1,0      | 1,3       | 1,6      | 2,5             | 4,7                  | 7                  | 15   | 30                    |
| 16        | 20                            | 25         | 32       | 40        | 50       | 75              | 115/110 <sup>5</sup> | 160 <sup>5</sup>   | -  | -                     |
| 16        | 16                            | 20         | 25       | 32        | 40       | 63 <sup>5</sup> | 110                  | 160                | -  | -                     |
| -         | -                             | -          | -        | -         | -        | -               | -                    | -                  | 400  | 630                   |
| 4 (14)    | 5,5 (17)                      | 7,5 (24)   | 8,5 (27) | 10 (32)   | 15 (48)  | 18,5 (58)       | 30 (95)              | 40 (125)           | -  | -                     |
| 7,5 (14)  | 9 (16)                        | 11 (20)    | 15 (27)  | 18,5 (30) | 25 (45)  | 30 (54)         | 45 (85)              | 59 (106)           | -  | -                     |
| -         | 9 (13)                        | 11 (15)    | 15 (22)  | 18,5 (27) | 33 (48)  | 22 (32)         | 30 (40)              | 75 (108)           | -  | -                     |
| -         | 9 (9)                         | 11 (11)    | 15 (16)  | 18,5 (19) | 22 (23)  | -               | -                    | -                  | -  | -                     |
| 1,1 (12)  | 1,1 (5)                       | 2,2 (25)   | 2,2 (25) | 3 (34)    | 3,7 (42) | 5,5 (63)        | 9 (102)              | 11 (125)           | -  | -                     |
| 2,2 (14)  | 3 (17)                        | 3,7(20)    | 3,7(20)  | 5,5 (30)  | 7,5 (40) | 10 (32)         | 15 (82)              | 22 (120)           | -  | -                     |
| 3,7 (12)  | 4 (13)                        | 5,5 (17)   | 5,5 (17) | 7,5 (24)  | 11 (35)  | 15 (47)         | 22 (70)              | 30 (95)            | -  | -                     |
| 5,5 (10)  | 7,5 (14)                      | 9,5 (16)   | 10 (17)  | 15 (27)   | 18 (33)  | 22 (40)         | 37 (67)              | 45 (82)            | -  | -                     |
| -         | 7,5 (11)                      | 9,5 (12,5) | 10 (14)  | 15 (22)   | 22 (32)  | 22 (32)         | 30 (40)              | 59 (85)            | -  | -                     |
| -         | 7,5 (8)                       | 8,5 (10)   | 10 (10)  | 16 (16)   | 20 (20)  | -               | -                    | -                  | -  | -                     |
| 0,75 (9)  | 1,1 (13)                      | 1,5 (17)   | 1,5 (17) | 2,2 (25)  | 3,7 (42) | 4 (45)          | 7,5 (85)             | 9 (102)            | -  | -                     |
| 1,5 (8)   | 2,2 (12)                      | 3 (17)     | 3 (17)   | 4,5 (25)  | 7,5 (40) | 7,5 (40)        | 11 (60)              | 15 (82)            | -  | -                     |
| -         | 3,7 (12)                      | -          | -        | -         | -        | -               | -                    | -                  | -  | -                     |
| -         | 1,5 (4,5)                     | 2,2 (7)    | 2,2 (7)  | 3 (10)    | 3,7 (12) | 5,5 (17)        | 7,5 (85)             | -                  | -  | -                     |
| -         | 2,2 (2,6)                     | 3 (5,5)    | 3 (5,5)  | 5,5 (10)  | 6 (11)   | 7,5 (14)        | 11 (20)              | -                  | -  | -                     |
| 6         | 7                             | 8          | 8        | 10        | -        | -               | -                    | -                  | -  | -                     |
| 4         | 5                             | 6          | 6        | 8         | -        | -               | -                    | -                  | -  | -                     |
| 112       | 136                           | 192        | 216      | 256       | 384      | 464             | 760                  | 1000               | -  | -                     |
| 112       | 128                           | 160        | 216      | 240       | 360      | 432             | 680                  | 848                | -  | -                     |
| 240       | 240                           | 400        | 400      | 500       | 600      | 800             | 1500                 | 2000               | -  | -                     |
| -         | 1500                          | 2000       | 2000     | 2000      | 2000     | 2500            | 3000                 | 3000               | -  | -                     |
| 4         | 5                             | 10         | 10       | 10        | 15       | 15              | 15                   | 15                 | -  | -                     |
| 20        | 20                            | 35         | 35       | 50        | 50       | 63              | 125                  | 200                | -  | -                     |
| 600/-     | 600/300                       | 600/600    | 600/600  | 600/600   | 600/600  | 600/600         | 600/600              | 600/-              | 600/- <sup>4</sup>   | 600/- <sup>4</sup>    |
| 600/-     | 600/300                       | 600/600    | 600/600  | 600/600   | 600/600  | 600/600         | 600/600              | 600/-              | 600/- <sup>4</sup>   | 600/- <sup>4</sup>    |
| 16        | 20/16                         | 25/25      | 35/25    | 40/32     | 60/40    | 85/63           | 125/100              | 240/-              | 400/- <sup>3 14</sup>  | 630/- <sup>3 14</sup> |
| 5000      | 5000                          |            |          |           |          |                 |                      |                    |  |                       |
| 25 (30)   | 60                            |            |          |           |          |                 |                      |                    |  |                       |
| 1 (16)    | 1,5 (20)/ -                   | 2/ -       | 2/ -     | 3/ 2,5    | 5/ -     | 7,5/ -          | 10/5                 | -                  | -  | -                     |
| 2 (12)    | 3 (17)/ 2,5 <sup>2</sup>      | 3/ 6       | 5/ -     | 7,5/ 4,5  | 10/ -    | 10/ -           | 15/12                | -                  | -  | -                     |
| 2 (7,8)   | 5 (16,7)/ -                   | 5/ -       | 7,5/5    | 10/ -     | 15/ -    | 20/ -           | 20/-                 | -                  | -  | -                     |
| 3 (9,6)   | 7,5 (22)/ 5 (16) <sup>2</sup> | 7,5/ -     | 10/ -    | 15/ 9,5   | 20/ -    | 20/ -           | 25/24                | -                  | -  | -                     |
| 7,5 (11)  | 10 (14)/ -                    | 10/ -      | 15/ -    | 20/ 20    | 30/ -    | 30/ -           | 40/50                | -                  | -  | -                     |
| 7,5 (9)   | 10 (11)/ -                    | 10/15      | 15/ 17   | 20/ 25    | 30/32,5  | 40/50           | 50/65                | -                  | -  | -                     |
| 2         | 2                             | 1,5        | 1,5      | 1,5       | 1,5      | 1               | 0,3                  | 0,1                | -  | -                     |
| 120       | 120                           | 120        | 120      | 120       | 120      | 120             | 120                  | 120                | -  | -                     |
| 2x1,5-4   | 2x1,5-4                       | 2x2,5-10   | 2x2,5-10 | 2x2,5-10  | 2x2,5-6  | 6-16            | 10-25                | 50-70 <sup>1</sup> | Terminals designed for cable lugs<br>or copper bars suitable for bolts |                       |
| 16-10     | 16-10                         | 16-8       | 16-8     | 16-8      | 14-8     | 10-6            | 10-3                 | 1/0-2/0            |  |                       |
| 2x1,5-6   | 2x1,5-6                       | 2x2,5-16   | 2x2,5-16 | 2x2,5-16  | 2x4-10   | 10-25           | 10-25                | 16-35              |  |                       |
| M3,5      | M3,5                          | M4         | M4       | M4        | M5       | 2XM5            | M8                   | M10                | M12X20   | M16x25                |
| 1,0       | 1,0                           | 47         | 47       | 47        | 2,8      | 2,8             | 2,8                  | 23                 | 40   | 98                    |
| 00        |                               |            |          |           |          |                 |                      |                    |  |                       |
| -25 ÷ +55 |                               |            |          |           |          |                 |                      |                    |  |                       |
| -30 ÷ +70 |                               |            |          |           |          |                 |                      |                    |  |                       |
| 2-78      |                               |            |          |           |          |                 |                      |                    |  |                       |
| 2-30      |                               |            |          |           |          |                 |                      |                    |  |                       |

Notes: 1 = Terminals for M10 bolts

2 = CSA at 300 V

3 = to use similar category AC20

4 = UR approval

5 = at 500 V



## CA 12-40A

### Standard plates and knobs



Rear mount with screw fixing



Base mount with screw fixing



**PL1** <sup>(1)</sup>

Transparent plate 52x52mm (2.05x2.05"), black knob, IP40



**PL2** <sup>(1)</sup>

Transparent plate 75x75mm (2.95x2.95"), black knob, IP40



**RL6** <sup>(2)</sup>

Yellow plate 67x67 mm (2.64"x2.64"), red padlockable knob (max 3 padlocks), IP66



**BL6** <sup>(2)</sup>

Yellow plate 67x67 mm (2.64"x2.64"), red padlockable knob (max 3 padlocks), IP66

### Optional plates and knobs



Rear mount with screw fixing



Base mount with screw fixing



**RT4** <sup>(2)</sup>

Gray plate 48x48mm, black knob, IP66



**RT6** <sup>(2)</sup>

Grey plate 67x67 mm (2.64"x2.64"), black knob, IP66



**RK6** <sup>(2)</sup>

Grey plate 67x67 mm (2.64"x2.64"), black padlockable knob (max 3 padlocks), IP66



**BK6** <sup>(2)</sup>

Grey plate 67x67 mm (2.64"x2.64"), black padlockable knob (max 3 padlocks), IP66

Possible fixing options in rear mount depend on the combination of the plate with the rear mount cam-switch body

- (1) suitable for 2-screw fixing with 2 holes at 28mm (1.10") vertical distance
- (2) suitable for 2-screw fixing with 2 holes at 28mm (1.10") vertical distance and 2 holes at 32mm (1.26") horizontal distance
- (3) suitable for both 2-screw fixing (with 2 holes at 28mm (1.10") vertical distance and 2 holes at 32mm (1.26") horizontal distance) and 4-screw fixing (with 4 holes at 36x36mm (1.42"x1.42") and 48x48mm (1.89"x1.89") distance)

standard plates    optional plates

**Rear mounting**

2-screw fixing: 28mm (1.10") V.





**PL1**





**PL2**



■ **ON-OFF switch 1 pole**

| <br>0001 | Circuit diagram | Rated nom. current  | Part no. | Pack         | Part no.     | Pack         |
|---|-----------------|---|----------|--------------|--------------|--------------|
|   |                 |  | 12A      | CA0120001PL1 | 1            | CA0120001PL2 |
|   |                 | 16A   |          |              | CA0160001PL2 | R            |
|   |                 | 20A   |          |              | CA0200001PL2 | R            |
|   |                 | 25A   |          |              | CA0250001PL2 | 1            |
|   |                 | 32A   |          |              |              |              |
|   |                 | 40A   |          |              |              |              |



■ **ON-OFF switch 2 pole**

| <br>0002 | Circuit diagram | Rated nom. current  | Part no.     | Pack         | Part no.     | Pack         |
|---|-----------------|---|--------------|--------------|--------------|--------------|
|   |                 |  | 12A          | CA0120002PL1 | 1            | CA0120002PL2 |
|   |                 | 16A   | CA0160002PL1 | R            | CA0160002PL2 | 1            |
|   |                 | 20A   | CA0200002PL1 | R            | CA0200002PL2 | 1            |
|   |                 | 25A   |              |              | CA0250002PL2 | 1            |
|   |                 | 32A   |              |              | CA0320002PL2 | 1            |
|   |                 | 40A   |              |              | CA0400002PL2 | R            |

■ **ON-OFF switch 3 pole**

| <br>0003 | Circuit diagram | Rated nom. current  | Part no.     | Pack         | Part no.     | Pack         |
|---|-----------------|---|--------------|--------------|--------------|--------------|
|   |                 |  | 12A          | CA0120003PL1 | 1            | CA0120003PL2 |
|   |                 | 16A   | CA0160003PL1 | R            | CA0160003PL2 | 1            |
|   |                 | 20A   | CA0200003PL1 | R            | CA0200003PL2 | 1            |
|   |                 | 25A   | CA0250003PL1 | R            | CA0250003PL2 | 1            |
|   |                 | 32A   |              |              | CA0320003PL2 | 1            |
|   |                 | 40A   |              |              | CA0400003PL2 | 1            |

■ **ON-OFF switch 4 pole**

| <br>0004 | Circuit diagram | Rated nom. current  | Part no.     | Pack         | Part no.     | Pack         |
|---|-----------------|---|--------------|--------------|--------------|--------------|
|   |                 |  | 12A          | CA0120004PL1 | 1            | CA0120004PL2 |
|   |                 | 16A   | CA0160004PL1 | R            | CA0160004PL2 | 1            |
|   |                 | 20A   |              |              | CA0200004PL2 | 1            |
|   |                 | 25A   |              |              | CA0250004PL2 | 1            |
|   |                 | 32A   |              |              | CA0320004PL2 | 1            |
|   |                 | 40A   |              |              | CA0400004PL2 | 1            |

 standard article

R = on Request

### Rear mounting

2-screw fixing: 28mm (1.10") V.



PL1



PL2

## Change-over switch 1 pole

| <br>0005 | Circuit diagram | Rated nom. current | Part no.     | Pack         | Part no.     | Pack |
|----------|-----------------|--------------------|--------------|--------------|--------------|------|
|          |                 | 12A                | CA0120005PL1 | 1            | CA0120005PL2 | R    |
| 16A      |                 |                    |              | CA0160005PL2 | 1            |      |
| 20A      |                 |                    |              | CA0200005PL2 | R            |      |
| 25A      |                 |                    |              | CA0250005PL2 | R            |      |
| 32A      |                 |                    |              |              |              |      |
| 40A      |                 |                    |              |              |              |      |

## Change-over switch 2 pole

| <br>0006 | Circuit diagram | Rated nom. current | Part no.     | Pack         | Part no.     | Pack |
|----------|-----------------|--------------------|--------------|--------------|--------------|------|
|          |                 | 12A                | CA0120006PL1 | 1            | CA0120006PL2 | R    |
| 16A      |                 | CA0160006PL1       | R            | CA0160006PL2 | 1            |      |
| 20A      |                 |                    |              | CA0200006PL2 | 1            |      |
| 25A      |                 |                    |              | CA0250006PL2 | 1            |      |
| 32A      |                 |                    |              | CA0320006PL2 | 1            |      |
| 40A      |                 |                    |              | CA0400006PL2 | 1            |      |

## Change-over switch 3 pole

| <br>0007 | Circuit diagram | Rated nom. current | Part no.     | Pack         | Part no.     | Pack |
|----------|-----------------|--------------------|--------------|--------------|--------------|------|
|          |                 | 12A                | CA0120007PL1 | 1            | CA0120007PL2 | R    |
| 16A      |                 | CA0160007PL1       | R            | CA0160007PL2 | 1            |      |
| 20A      |                 |                    |              | CA0200007PL2 | 1            |      |
| 25A      |                 |                    |              | CA0250007PL2 | 1            |      |
| 32A      |                 |                    |              | CA0320007PL2 | 1            |      |
| 40A      |                 |                    |              | CA0400007PL2 | 1            |      |

## Change-over switch 4 pole

| <br>0039 | Circuit diagram | Rated nom. current | Part no.     | Pack         | Part no.     | Pack |
|----------|-----------------|--------------------|--------------|--------------|--------------|------|
|          |                 | 12A                | CA0120039PL1 | 1            | CA0120039PL2 | R    |
| 16A      |                 | CA0160039PL1       | R            | CA0160039PL2 | 1            |      |
| 20A      |                 |                    |              | CA0200039PL2 | 1            |      |
| 25A      |                 |                    |              | CA0250039PL2 | 1            |      |
| 32A      |                 |                    |              | CA0320039PL2 | 1            |      |
| 40A      |                 |                    |              | CA0400039PL2 | 1            |      |

standard article

R = on Request



**Rear mounting**

2-screw fixing: 28mm (1.10") V.



**PL1**



**PL2**

■ **Reversing switch 3 pole**

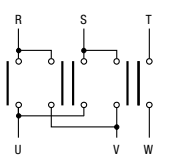
| <br><b>0008</b> | Circuit diagram | Rated nom. current  | Part no.     | Pack         | Part no.     | Pack         |
|--|-----------------|---|--------------|--------------|--------------|--------------|
|  |                 |  | 12A          | CA0120008PL1 | 1            | CA0120008PL2 |
|  |                 | 16A   | CA0160008PL1 | R            | CA0160008PL2 | 1            |
|  |                 | 20A   |              |              | CA0200008PL2 | 1            |
|  |                 | 25A   |              |              | CA0250008PL2 | 1            |
|  |                 | 32A   |              |              | CA0320008PL2 | 1            |
|  |                 | 40A   |              |              | CA0400008PL2 | 1            |

■ **Reversing switch 3 pole with spring return to "OFF"**

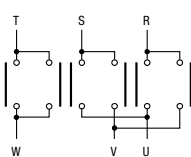
| <br><b>0036</b> | Circuit diagram | Rated nom. current  | Part no. | Pack         | Part no.     | Pack         |
|--|-----------------|---|----------|--------------|--------------|--------------|
|  |                 |  | 12A      | CA0120036PL1 | 1            | CA0120036PL2 |
|  |                 | 16A   |          |              | CA0160036PL2 | 1            |
|  |                 | 20A   |          |              | CA0200036PL2 | R            |
|  |                 | 25A   |          |              |              |              |
|  |                 | 32A   |          |              |              |              |
|  |                 | 40A   |          |              |              |              |

■ **Changing switch Dahlander pole**

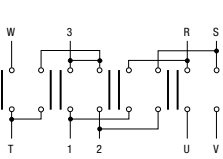
| <br><b>0009</b> | Circuit diagram | Rated nom. current  | Part no.     | Pack         | Part no.     | Pack         |
|--|-----------------|---|--------------|--------------|--------------|--------------|
|  |                 |  | 12A          | CA0120009PL1 | 1            | CA0120009PL2 |
|  |                 | 16A   | CA0160009PL1 | R            | CA0160009PL2 | 1            |
|  |                 | 20A   |              |              | CA0200009PL2 | 1            |
|  |                 | 25A   |              |              | CA0250009PL2 | 1            |
|  |                 | 32A   |              |              | CA0320009PL2 | 1            |
|  |                 | 40A   |              |              | CA0400009PL2 | 1            |

■ **STAR-DELTA Starter**

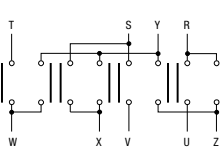
| <br><b>0010</b> | Circuit diagram | Rated nom. current  | Part no.     | Pack         | Part no.     | Pack         |
|--|-----------------|---|--------------|--------------|--------------|--------------|
|  |                 |  | 12A          | CA0120010PL1 | 1            | CA0120010PL2 |
|  |                 | 16A   | CA0160010PL1 | R            | CA0160010PL2 | 1            |
|  |                 | 20A   |              |              | CA0200010PL2 | 1            |
|  |                 | 25A   |              |              | CA0250010PL2 | 1            |
|  |                 | 32A   |              |              | CA0320010PL2 | 1            |
|  |                 | 40A   |              |              | CA0400010PL2 | 1            |

 standard article

R = on Request

### Rear mounting

2-screw fixing: 28mm (1.10") V.



**PL1**



**PL2**

## Reversing switch pole changing

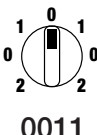
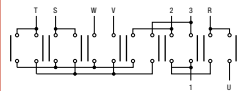
| <br><b>0011</b> | Circuit diagram | Rated nom. current  | Part no.     | Pack         | Part no.     | Pack         |
|---|-----------------|---|--------------|--------------|--------------|--------------|
|   |                 |  | 12A          | CA0120011PL1 | 1            | CA0120011PL2 |
|   |                 | 16A   | CA0160011PL1 | R            | CA0160011PL2 | 1            |
|   |                 | 20A   |              |              | CA0200011PL2 | 1            |
|   |                 | 25A   |              |              | CA0250011PL2 | R            |
|   |                 | 32A   |              |              |              |              |
|   |                 | 40A   |              |              |              |              |

## Switch single phase motor + aux phase

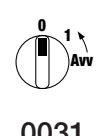
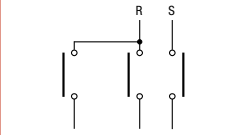
| <br><b>0031</b> | Circuit diagram | Rated nom. current  | Part no. | Pack         | Part no.     | Pack         |
|---|-----------------|---|----------|--------------|--------------|--------------|
|   |                 |  | 12A      | CA0120031PL1 | 1            | CA0120031PL2 |
|   |                 | 16A   |          |              | CA0160031PL2 | 1            |
|   |                 | 20A   |          |              | CA0200031PL2 | 1            |
|   |                 | 25A   |          |              | CA0250031PL2 | 1            |
|   |                 | 32A   |          |              |              |              |
|   |                 | 40A   |          |              |              |              |

## Reversing switch single-phase motor + centrif.

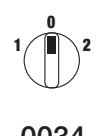
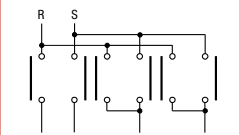
| <br><b>0034</b> | Circuit diagram | Rated nom. current  | Part no.     | Pack         | Part no.     | Pack         |
|---|-----------------|---|--------------|--------------|--------------|--------------|
|   |                 |  | 12A          | CA0120034PL1 | 1            | CA0120034PL2 |
|   |                 | 16A   | CA0160034PL1 | R            | CA0160034PL2 | 1            |
|   |                 | 20A   |              |              | CA0200034PL2 | R            |
|   |                 | 25A   |              |              | CA0250034PL2 | R            |
|   |                 | 32A   |              |              |              |              |
|   |                 | 40A   |              |              |              |              |

## Voltmeter switch 3 concatenated voltages

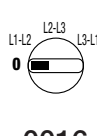
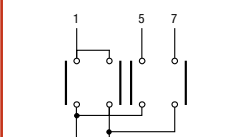
| <br><b>0016</b> | Circuit diagram | Rated nom. current  | Part no. | Pack         | Part no.     | Pack         |
|---|-----------------|---|----------|--------------|--------------|--------------|
|   |                 |  | 12A      | CA0120016PL1 | 1            | CA0120016PL2 |
|   |                 | 16A   |          |              | CA0160016PL2 | R            |
|   |                 | 20A   |          |              |              |              |
|   |                 | 25A   |          |              |              |              |
|   |                 | 32A   |          |              |              |              |
|   |                 | 40A   |          |              |              |              |

 standard article

R = on Request

**Rear mounting**

2-screw fixing: 28mm (1.10") V.



**PL1**



**PL2**

■ Voltmeter switch 3 concatenated voltages and 3 phase voltages

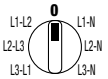
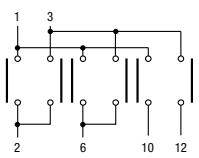
| <br><b>0018</b> | Circuit diagram   | Rated nom. current | Part no.            | Pack                | Part no.            | Pack |
|---|---|--------------------|---------------------|---------------------|---------------------|------|
|   |  | 12A                | <b>CA0120018PL1</b> | 1                   | <b>CA0120018PL2</b> | R    |
| 16A   |   |                    |                     | <b>CA0160018PL2</b> | R                   |      |
| 20A   |   |                    |                     |                     |                     |      |
| 25A   |   |                    |                     |                     |                     |      |
| 32A   |   |                    |                     |                     |                     |      |
| 40A   |   |                    |                     |                     |                     |      |

■ Ammeter switch 1 pole 3 current transformers

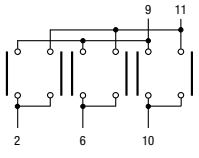
| <br><b>0022</b> | Circuit diagram   | Rated nom. current | Part no.            | Pack                | Part no.            | Pack |
|--|---|--------------------|---------------------|---------------------|---------------------|------|
|  |  | 12A                | <b>CA0120022PL1</b> | 1                   | <b>CA0120022PL2</b> | R    |
| 16A  |   |                    |                     | <b>CA0160022PL2</b> | R                   |      |
| 20A  |   |                    |                     |                     |                     |      |
| 25A  |   |                    |                     |                     |                     |      |
| 32A  |   |                    |                     |                     |                     |      |
| 40A  |   |                    |                     |                     |                     |      |

■ Multi step switch with off 1 pole 3 steps

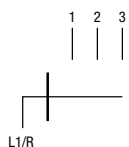
| <br><b>MZ13</b> | Circuit diagram   | Rated nom. current  | Part no.            | Pack                | Part no.            | Pack |
|--|---|---------------------|---------------------|---------------------|---------------------|------|
|  |  | 12A                 | <b>CS012MZ13PL1</b> | 1                   | <b>CS012MZ13PL2</b> | R    |
| 16A  |   | <b>CS016MZ13PL1</b> | R                   | <b>CS016MZ13PL2</b> | R                   |      |
| 20A  |   |                     |                     | <b>CS020MZ13PL2</b> | R                   |      |
| 25A  |   |                     |                     |                     |                     |      |
| 32A  |   |                     |                     |                     |                     |      |
| 40A  |   |                     |                     |                     |                     |      |

■ Multi step switch with off 1 pole 4 steps

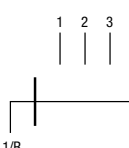
| <br><b>MZ14</b> | Circuit diagram   | Rated nom. current  | Part no.            | Pack                | Part no.            | Pack |
|--|---|---------------------|---------------------|---------------------|---------------------|------|
|  |  | 12A                 | <b>CS012MZ14PL1</b> | 1                   | <b>CS012MZ14PL2</b> | R    |
| 16A  |   | <b>CS016MZ14PL1</b> | R                   | <b>CS016MZ14PL2</b> | R                   |      |
| 20A  |   |                     |                     |                     |                     |      |
| 25A  |   |                     |                     |                     |                     |      |
| 32A  |   |                     |                     |                     |                     |      |
| 40A  |   |                     |                     |                     |                     |      |

 standard article

R = on Request

### Rear mounting

2-screw fixing: 28mm (1.10") V.



**PL1**



**PL2**

## Multi step switch with off 2 pole 3 steps

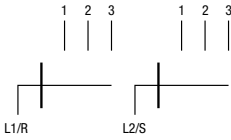
| <br><b>MZ23</b> | Circuit diagram | Rated nom. current  | Part no. | Pack                | Part no.            | Pack                |
|--|-----------------|---|----------|---------------------|---------------------|---------------------|
|  |                 |  | 12A      | <b>CS012MZ23PL1</b> | 1                   | <b>CS012MZ23PL2</b> |
|  |                 | 16A   |          |                     | <b>CS016MZ23PL2</b> | R                   |
|  |                 | 20A   |          |                     |                     |                     |
|  |                 | 25A   |          |                     |                     |                     |
|  |                 | 32A   |          |                     |                     |                     |
|  |                 | 40A   |          |                     |                     |                     |

### Rear mounting

2-screw fixing: 28mm (1.10") V. / 32mm (1.26") H.



**RL6**



**RK6**

### Base mounting\*

2-screw fixing: 28mm (1.10") V. / 32mm (1.26") H.



**BL6**



**BK6**

## ON-OFF switch 3 pole with padlockable handle

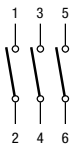
| <br><b>00G3</b> | Circuit diagram | Rated nom. current  | Part no.            | Pack                | Part no.            | Pack                | Part no.            | Pack                | Part no.            | Pack                |
|---|-----------------|---|---------------------|---------------------|---------------------|---------------------|---------------------|---------------------|---------------------|---------------------|
|   |                 |  | 12A                 | <b>CA01200G3RL6</b> | 1                   | <b>CA01200G3RK6</b> | R                   | <b>CA01200G3BL6</b> | 1                   | <b>CA01200G3BK6</b> |
|   |                 | 16A   | <b>CA01600G3RL6</b> | 1                   | <b>CA01600G3RK6</b> | R                   | <b>CA01600G3BL6</b> | 1                   | <b>CA01600G3BK6</b> | R                   |
|   |                 | 20A   | <b>CA02000G3RL6</b> | 1                   | <b>CA02000G3RK6</b> | R                   | <b>CA02000G3BL6</b> | 1                   | <b>CA02000G3BK6</b> | R                   |
|   |                 | 25A   | <b>CA02500G3RL6</b> | 1                   | <b>CA02500G3RK6</b> | R                   | <b>CA02500G3BL6</b> | 1                   | <b>CA02500G3BK6</b> | R                   |
|   |                 | 32A   | <b>CA03200G3RL6</b> | 1                   | <b>CA03200G3RK6</b> | R                   | <b>CA03200G3BL6</b> | 1                   | <b>CA03200G3BK6</b> | R                   |
|   |                 | 40A   | <b>CA04000G3RL6</b> | 1                   | <b>CA04000G3RK6</b> | R                   | <b>CA04000G3BL6</b> | 1                   | <b>CA04000G3BK6</b> | R                   |

\* Base mounting switches are supplied with standard 175mm (6.89") shaft



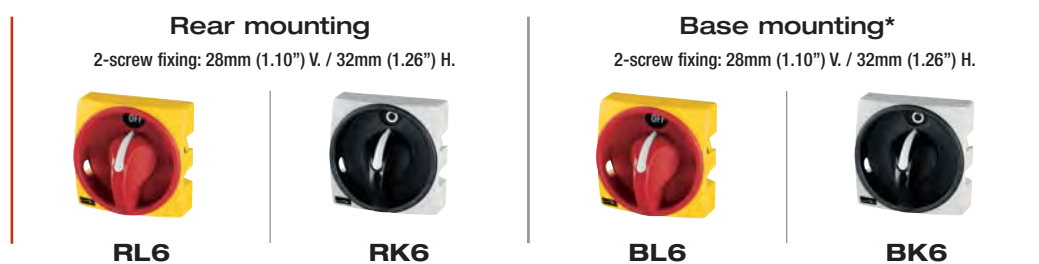

### ON-OFF switch 4 pole with padlockable handle

| Circuit diagram | Rated nom. current | Part no.     |      | Part no.     |      | Part no.     |      | Part no.     |      |
|-----------------|--------------------|--------------|------|--------------|------|--------------|------|--------------|------|
|                 |                    | Part no.     | Pack | Part no.     | Pack | Part no.     | Pack | Part no.     | Pack |
|                 | 12A                | CA01200G4RL6 | R    | CA01200G4RK6 | R    | CA01200G4BL6 | R    | CA01200G4BK6 | R    |
|                 | 16A                | CA01600G4RL6 | 1    | CA01600G4RK6 | R    | CA01600G4BL6 | 1    | CA01600G4BK6 | R    |
|                 | 20A                | CA02000G4RL6 | 1    | CA02000G4RK6 | R    | CA02000G4BL6 | 1    | CA02000G4BK6 | R    |
|                 | 25A                | CA02500G4RL6 | 1    | CA02500G4RK6 | R    | CA02500G4BL6 | 1    | CA02500G4BK6 | R    |
|                 | 32A                | CA03200G4RL6 | 1    | CA03200G4RK6 | R    | CA03200G4BL6 | 1    | CA03200G4BK6 | R    |
|                 | 40A                | CA04000G4RL6 | 1    | CA04000G4RK6 | R    | CA04000G4BL6 | 1    | CA04000G4BK6 | R    |

\* Base mounting switches are supplied with standard 175mm (6.89") shaft



### Handle R03

Circuit diagram

| Rated nom. current | 0002         |      | 0003         |      | 0008         |      | 0009         |      | 0011         |      |
|--------------------|--------------|------|--------------|------|--------------|------|--------------|------|--------------|------|
|                    | Part no.     | Pack | Part no.     | Pack | Part no.     | Pack | Part no.     | Pack | Part no.     | Pack |
| 12A                | CA0120002R03 | R    |              |      | CA0120008R03 | R    | CA0120009R03 | R    | CA0120011R03 | R    |
| 16A                | CA0160002R03 | R    | CA0160003R03 | R    | CA0160008R03 | R    | CA0160009R03 | R    | CA0160011R03 | R    |
| 20A                | CA0200002R03 | R    | CA0200003R03 | R    | CA0200008R03 | R    | CA0200009R03 | R    | CA0200011R03 | R    |
| 25A                | CA0250002R03 | R    | CA0250003R03 | R    |              |      |              |      |              |      |

standard article

R = on Request

## Switches with electromagnet



Device with safety electromagnet. It allows the spring return of the switch to "OFF" position in case of supply failure.

|     | B  | H     |
|-----|----|-------|
| PL2 | 32 | 75x75 |
| RT6 | 39 | 67x67 |
| RL6 | 39 | 67x67 |

dimensions in mm

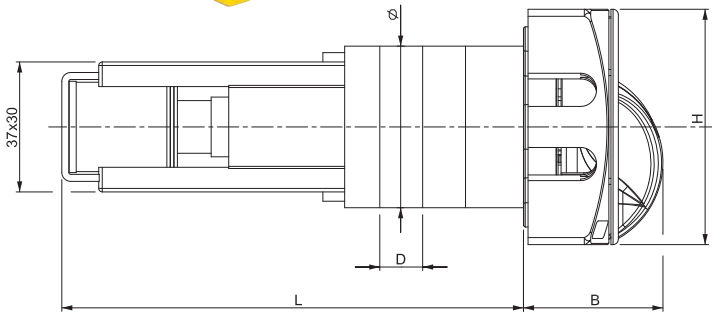

dimensions in mm

| Stages no.                      | 2 |       |
|---------------------------------|---|-------|
| CA 016<br>D = 12,2<br>ø = 40x46 | L | 126   |
| CA 025<br>D = 16,2<br>ø = 58    | L | 140,5 |



**RL6**



**PL2**

### Rear mounting

Circuit diagram

0035

| Rated nom. current | Part no.       | Pack | Part no.       | Pack | Part no.       | Pack | Part no.       | Pack |
|--------------------|----------------|------|----------------|------|----------------|------|----------------|------|
| 16A                | CA0160035E3RL6 | 1    | CA0160035E3PL2 | 1    | CA0160035E4PL2 | R    | CA0160035E5PL2 | R    |
| 25A                | CA0250035E3RL6 | 1    |                |      |                |      |                |      |
| * rat. n. voltage  | 110V           |      | 110V           |      | 220V           |      | 380V           |      |



**RT6**

### Rear mounting

Circuit diagram

0035







| Rated nom. current | Part no.       | Pack | Part no.       | Pack | Part no.       | Pack |
|--------------------|----------------|------|----------------|------|----------------|------|
| 16A                | CA0160035E3RT6 | R    | CA0160035E4RT6 | R    | CA0160035E5RT6 | R    |
| 25A                | CA0250035E3RT6 | R    | CA0250035E4RT6 | R    | CA0250035E5RT6 | R    |
| * rat. n. voltage  | 110V           |      | 220V           |      | 380V           |      |

\* Rated nominal voltage



standard article

R = on Request

Plates

|   | Part no.             | Description  | Handle fixing option | Legend included    |         | Pack   |
|---|----------------------|--|----------------------|--------------------|---------|--------|
|   |                      |  |                      | Type               | Degrees |        |
|    | FINPL1Q5             | transparent plate 52x52mm (2.05x2.05"), black knob, IP40                       | with 2 screws        | 0 - 1<br>1 - 0 - 2 | 60°     | 5      |
|    | FINPL2Q5             | transparent plate 75x75mm (2.95x2.95"), black knob, IP40                       | with 2 screws        | 0 - 1<br>1 - 0 - 2 | 60°     | 5      |
|    | FINRK6Q5<br>FINBK6Q5 | grey plate 67x67mm (2.64x2.64"), black padlockable knob (max 3 padlocks), IP66 | with 2 screws        | 0 - 1              | 90°     | 5<br>5 |
|    | FINRL6Q5<br>FINBL6Q5 | yellow plate 67x67mm (2.64x2.64"), red padlockable knob (max 3 padlocks), IP66 | with 2 screws        | 0 - 1              | 90°     | 5<br>5 |
|   | FINRT6Q5             | grey plate 67x67mm (2.64x2.64"), black knob, IP66                              | with 2 screws        | 0 - 1<br>1 - 0 - 2 | 60°     | 5      |
|  | FINRT4Q5             | grey plate 48x48mm (1.89x1.89"), black knob, IP66                              | with 2 screws        | 0 - 1<br>1 - 0 - 2 | 60°     | 5      |

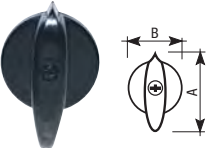
Knobs

|   | Part no.   | Description   | Pack |
|---|------------|---|------|
|  | M4G083N10  | Black knob square section 5mm (0.20") 41x28 mm (1.61x1.10") | 10   |
|   | M5G025N10  | Black knob square section 5mm (0.20") 50x34 mm (1.97x1.34") | 10   |
|   | M05G028N10 | Black knob square section 5mm (0.20") 50x34 mm (1.97x1.34") | 10   |
|   | M6G086N10  | Black knob square section 7mm (0.28") 70x48 mm (2.76x1.89") | 10   |
|  | MRN0N10    | black round knob Ø 38mm (1.50") square section 5mm (0.20")  | 10   |

 standard article

R = on Request

## Protections

PVC protections against dust and dirt are available on request.



### Terminal protection for diagrams 00G3,00G4



| Part no.   | Description                               | Pack |
|------------|---|------|
| PROTLE6747 | Terminals protection CA012 ÷ 020 2 stages | 5    |
| PROTLE6748 | Terminals protection CA025 ÷ 040 2 stages | 5    |

### Optional shafts



| Part no. | Description      | Pack |
|----------|------------------|------|
| PALBL300 | Shaft L=300mm 05 | 5    |
| PALBL500 | Shaft L=500mm 05 | 5    |
| PALBL065 | Shaft L=65mm 05  | R    |
| PALBL075 | Shaft L=75mm 05  | R    |
| PALBL095 | Shaft L=95mm 05  | R    |
| PALBL115 | Shaft L=115mm 05 | R    |
| PALBL135 | Shaft L=135mm 05 | R    |
| PALBL155 | Shaft L=155mm 05 | R    |
| PALBL175 | Shaft L=175mm 05 | 5    |



■ Rear mounting - PL Handle

Measures in mm (in)

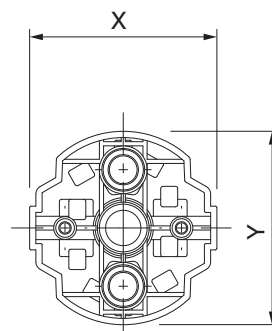
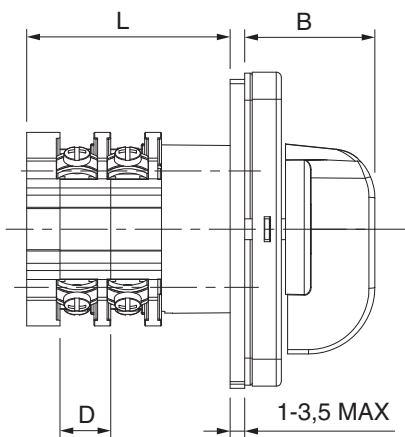

| Series         | X       | Y         | D       |   | no. of stages |         |         |         |         |         |
|----------------|---------|-----------|---------|---|---------------|---------|---------|---------|---------|---------|
|                |         |           |         |   | 1             | 2       | 3       | 4       | 5       | 6       |
| CA 012-016-020 | 45      | ∅ 46,5    | 12,2    | L | 36,7          | 49      | 61,1    | 73,3    | 85,5    | 97,7    |
|                | (1,77") | ∅ (1,83") | (0,48") |   | (1,44")       | (1,93") | (2,41") | (2,89") | (3,37") | (3,85") |
| CA 025-032-040 | -       | ∅ 58,5    | 16,2    | L | 42,8          | 59      | 75      | 91,5    | 108     | 124     |
|                | -       | ∅ (2,30") | (0,64") |   | (1,69")       | (2,32") | (2,95") | (3,60") | (4,25") | (4,88") |

| Handle | B          |
|--------|------------|
| PL1    | 30 (1,18") |
| PL2    | 32 (1,26") |

## ■ Base mounting - Handles BL6/BK6

(switching angle 90°, padlockable with max 3 padlocks)

Measures in mm (in)

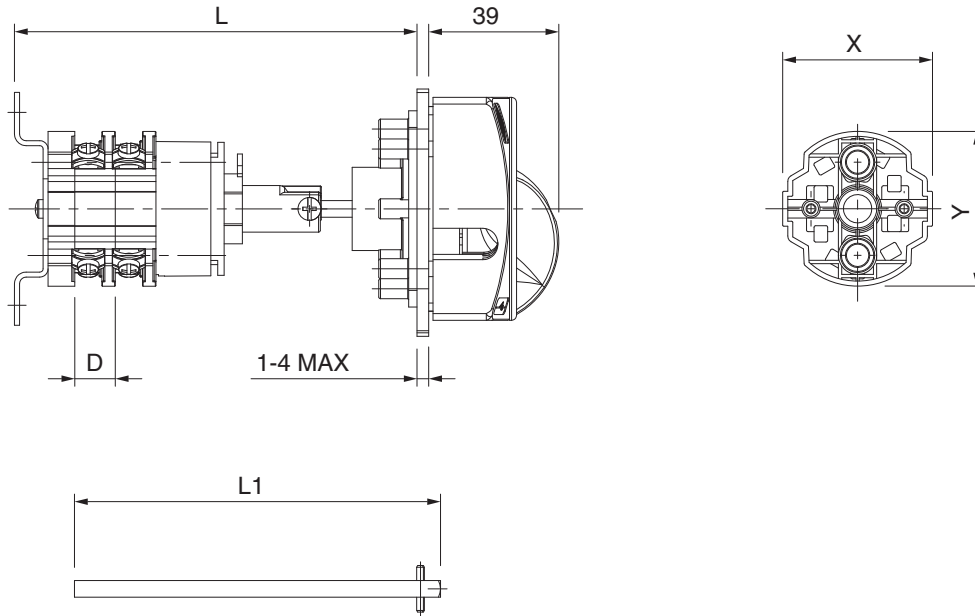

Overall length (min-max)\*\* for different shaft lengths (L1):

| Series         | no. of stages |           |         | L1           | 2           |              |
|----------------|---------------|-----------|---------|--------------|-------------|--------------|
|                | X             | Y         | D       |              | Lmin        | Lmax         |
| CA 012-016-020 | 45            | ∅ 46,5    | 12,2    | 175 (6.89")* | 114 (4,49") | 258 (10,16") |
|                | (1.77")       | ∅ (1.83") | (0.48") | 300 (11.81") | 114 (4,49") | 383 (15,08") |
|                |               |           |         | 500 (19.69") | 114 (4,49") | 583 (22,95") |
| CA 025-032-040 | -             | ∅ 58,5    | 16,2    | 175 (6.89")* | 117 (4,61") | 261 (10,28") |
|                | -             | ∅ (2.30") | (0.64") | 300 (11.81") | 117 (4,61") | 386 (15,20") |
|                |               |           |         | 500 (19.69") | 117 (4,61") | 586 (23,07") |

\* Standard shaft, bundled

\*\* Minimum length is obtainable by cutting the shaft

■ Drilling templates - Rear mounting

(RT - RL - RK) - Measures in mm (in)

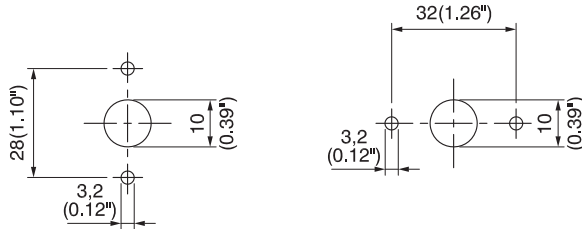

(PL)

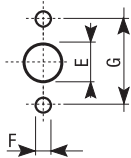

Dimensions

| cod. | E  |      | F   |      | G  |      |
|------|----|------|-----|------|----|------|
| PL1  | 10 | 0.39 | 3,2 | 0.15 | 28 | 1.10 |
| PL2  | 10 | 0.39 | 3,2 | 0.15 | 28 | 1.10 |

■ Drilling templates - Base mounting

(BL6 - BK6) - Measures in mm (in)

Escutcheon plate mounting options:

1) 2 holes with vertical distance 28mm (1.10")

2) 2 holes with horizontal distance 32mm (1.26")

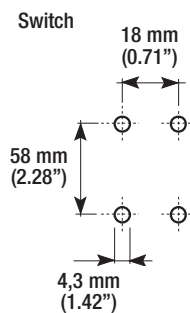
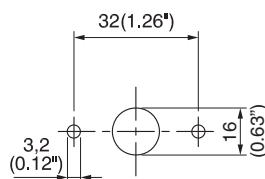
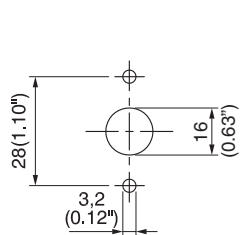

Switch mounting options:

1) 4 holes with distance 58x18mm (2.28x0.71")

## CA 50-630A

### Standard plates and knobs



Rear mount with screw fixing



Base mount with screw fixing



**PL3** <sup>(1)</sup>

Transparent plate 105x105mm (4.13x4.13"), black knob, IP40



**PL4** <sup>(2)</sup>

Transparent plate 130x130mm (5.12x5.12"), black knob, IP40



**3L3** <sup>(1)</sup>

Yellow plate 105x105mm (4.13x4.13"), red padlockable knob (max 3 padlocks), IP40



**3L4** <sup>(2)</sup>

Yellow plate 130x130mm (5.12x5.12"), red padlockable knob (max 3 padlocks), IP40



**LE3** <sup>(3)</sup>

Yellow plate 105x105mm (4.13x4.13"), red padlockable knob (max 3 padlocks), door interlock in "ON" position, IP54, terminals cover

**LE4** <sup>(4)</sup>

Yellow plate 130x130mm (5.12x5.12"), red padlockable knob (max 3 padlocks), door interlock in "ON" position, IP54, terminals cover

### Optional plates and knobs



Rear mount with screw fixing



Base mount with screw fixing



**PL9** <sup>(2)</sup>

Transparent plate 130x130mm (5.12x5.12"), black lever length 115 mm (4.53"), IP40



**PL5** <sup>(2)</sup>

Transparent plate 130x130mm (5.12x5.12"), black handwheel, IP40



**3N3** <sup>(1)</sup>

Grey plate 105x105mm (4.13x4.13"), black padlockable knob (max 3 padlocks), IP40



**LN3** <sup>(3)</sup>

Grey plate 105x105mm (4.13x4.13"), black padlockable knob (max 3 padlocks), door interlock in "ON" position, IP54, terminals cover

**LN4** <sup>(4)</sup>

Grey plate 130x130mm (5.12x5.12"), black padlockable knob (max 3 padlocks), door interlock in "ON" position, IP54, terminals cover

Possible fixing options in rear mount depend on the combination of the plate with the rear mount cam-switch body

- (1) suitable for 2-screw fixing with 2 holes at 40mm (1.57") vertical distance
- (2) suitable for 4-screw fixing with holes at 30 x 90mm (1.18" x 3.54") distance
- (3) suitable for 4-screw fixing with □ 65 ÷ 85mm (□ 2,56" ÷ 3.35") holes layout
- (4) suitable for 4-screw fixing with □ 94 ÷ 110mm (□ 3,70" ÷ 4.33") holes layout

standard plates    optional plates



Rear mounting



PL3



PL4



PL9



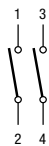

PL5

■ ON-OFF switch 2 pole

| <br>0002 | Circuit diagram   | Rated nom. current | Part no.     | Pack | Part no. | Pack | Part no. | Pack | Part no. | Pack |
|--|---|--------------------|--------------|------|----------|------|----------|------|----------|------|
|  |  | 50A                | CA0500002PL3 | R    |          |      |          |      |          |      |
|  | 63A   | CA0630002PL3       | R            |      |          |      |          |      |          |      |
|  | 100A  |                    |              |      |          |      |          |      |          |      |
|  | 200A  |                    |              |      |          |      |          |      |          |      |
|  | 400A  |                    |              |      |          |      |          |      |          |      |
|  | 630A  |                    |              |      |          |      |          |      |          |      |

■ ON-OFF switch 3 pole

| <br>0003 | Circuit diagram   | Rated nom. current | Part no.     | Pack         | Part no. | Pack         | Part no. | Pack         | Part no. | Pack |
|--|---|--------------------|--------------|--------------|----------|--------------|----------|--------------|----------|------|
|  |  | 50A                | CA0500003PL3 | 1            |          |              |          |              |          |      |
|  | 63A   | CA0630003PL3       | 1            |              |          |              |          |              |          |      |
|  | 100A  |                    |              | CA1000003PL4 | 1        | CA1000003PL9 | R        |              |          |      |
|  | 200A  |                    |              | CA2000003PL4 | 1        | CA2000003PL9 | R        |              |          |      |
|  | 400A  |                    |              | CA4000003PL4 | R        | CA4000003PL9 | R        |              |          |      |
|  | 630A  |                    |              |              |          |              |          | CA6300003PL5 | R        |      |

■ ON-OFF switch 4 pole

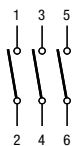
| <br>0004 | Circuit diagram   | Rated nom. current | Part no.     | Pack         | Part no. | Pack         | Part no. | Pack | Part no. | Pack |
|--|---|--------------------|--------------|--------------|----------|--------------|----------|------|----------|------|
|  |  | 50A                | CA0500004PL3 | 1            |          |              |          |      |          |      |
|  | 63A   | CA0630004PL3       | 1            |              |          |              |          |      |          |      |
|  | 100A  |                    |              | CA1000004PL4 | 1        | CA1000004PL9 | R        |      |          |      |
|  | 200A  |                    |              | CA2000004PL4 | 1        | CA2000004PL9 | R        |      |          |      |
|  | 400A  |                    |              |              |          |              |          |      |          |      |
|  | 630A  |                    |              |              |          |              |          |      |          |      |

 standard article

R = on Request

## Rear mounting



**PL3**



**PL4**



**PL9**



**PL5**

### Change-over switch 2 pole

| <br>0006 | Circuit diagram | Rated nom. current | Part no.     | Pack         | Part no.     | Pack | Part no.     | Pack | Part no.     | Pack |
|----------|-----------------|--------------------|--------------|--------------|--------------|------|--------------|------|--------------|------|
|          |                 |                    | 50A          | CA0500006PL3 | 1            |      |              |      |              |      |
|          |                 | 63A                | CA0630006PL3 | 1            |              |      |              |      |              |      |
|          |                 | 100A               |              |              | CA1000006PL4 | 1    | CA1000006PL9 | R    |              |      |
|          |                 | 200A               |              |              | CA2000006PL4 | 1    | CA2000006PL9 | R    |              |      |
|          |                 | 400A               |              |              |              |      | CA4000006PL9 | R    | CA4000006PL5 | R    |
|          |                 | 630A               |              |              |              |      | CA6300006PL9 | R    | CA6300006PL5 | R    |

### Change-over switch 3 pole

| <br>0007 | Circuit diagram | Rated nom. current | Part no.     | Pack         | Part no.     | Pack | Part no.     | Pack | Part no.     | Pack |
|----------|-----------------|--------------------|--------------|--------------|--------------|------|--------------|------|--------------|------|
|          |                 |                    | 50A          | CA0500007PL3 | 1            |      |              |      |              |      |
|          |                 | 63A                | CA0630007PL3 | 1            |              |      |              |      |              |      |
|          |                 | 100A               |              |              | CA1000007PL4 | 1    | CA1000007PL9 | R    |              |      |
|          |                 | 200A               |              |              | CA2000007PL4 | 1    | CA2000007PL9 | R    |              |      |
|          |                 | 400A               |              |              |              |      | CA4000007PL9 | R    | CA4000007PL5 | R    |
|          |                 | 630A               |              |              |              |      |              |      | CA6300007PL5 | R    |

### Change-over switch 4 pole

| <br>0039 | Circuit diagram | Rated nom. current | Part no.     | Pack         | Part no.     | Pack | Part no.     | Pack | Part no.     | Pack |
|----------|-----------------|--------------------|--------------|--------------|--------------|------|--------------|------|--------------|------|
|          |                 |                    | 50A          | CA0500039PL3 | 1            |      |              |      |              |      |
|          |                 | 63A                | CA0630039PL3 | 1            |              |      |              |      |              |      |
|          |                 | 100A               |              |              | CA1000039PL4 | 1    | CA1000039PL9 | R    |              |      |
|          |                 | 200A               |              |              | CA2000039PL4 | 1    | CA2000039PL9 | R    |              |      |
|          |                 | 400A               |              |              |              |      |              |      | CA4000039PL5 | R    |
|          |                 | 630A               |              |              |              |      |              |      | CA6300039PL5 | R    |

standard article

R = on Request

Rear mounting



PL3



PL4



PL9



PL5

Reversing switch 3 pole

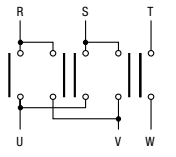
| <br>0008 | Circuit diagram   | Rated nom. current | Part no.     | Pack         | Part no. | Pack         | Part no. | Pack         | Part no. | Pack |
|--|---|--------------------|--------------|--------------|----------|--------------|----------|--------------|----------|------|
|  |  | 50A                | CA0500008PL3 | 1            |          |              |          |              |          |      |
| 63A  |   | CA0630008PL3       | 1            |              |          |              |          |              |          |      |
| 100A   |   |                    |              | CA1000008PL4 | 1        | CA1000008PL9 | R        |              |          |      |
| 200A   |   |                    |              | CA2000008PL4 | 1        | CA2000008PL9 | R        |              |          |      |
| 400A   |   |                    |              |              |          | CA4000008PL9 | R        | CA4000008PL5 | R        |      |
| 630A   |   |                    |              |              |          |              |          | CA6300008PL5 | R        |      |

Changing switch Dahlander pole

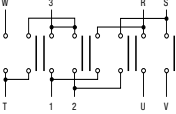
| <br>0009 | Circuit diagram   | Rated nom. current | Part no.     | Pack | Part no. | Pack | Part no. | Pack | Part no. | Pack |
|--|---|--------------------|--------------|------|----------|------|----------|------|----------|------|
|  |  | 50A                | CA0500009PL3 | 1    |          |      |          |      |          |      |
| 63A  |   | CA0630009PL3       | 1            |      |          |      |          |      |          |      |
| 100A   |   |                    |              |      |          |      |          |      |          |      |
| 200A   |   |                    |              |      |          |      |          |      |          |      |
| 400A   |   |                    |              |      |          |      |          |      |          |      |
| 630A   |   |                    |              |      |          |      |          |      |          |      |

STAR-DELTA Starter

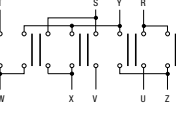
| <br>0010 | Circuit diagram   | Rated nom. current | Part no.     | Pack         | Part no. | Pack         | Part no. | Pack | Part no. | Pack |
|--|---|--------------------|--------------|--------------|----------|--------------|----------|------|----------|------|
|  |  | 50A                | CA0500010PL3 | 1            |          |              |          |      |          |      |
| 63A  |   | CA0630010PL3       | 1            |              |          |              |          |      |          |      |
| 100A   |   |                    |              | CA1000010PL4 | 1        | CA1000010PL9 | R        |      |          |      |
| 200A   |   |                    |              | CA2000010PL4 | 1        | CA2000010PL9 | R        |      |          |      |
| 400A   |   |                    |              |              |          |              |          |      |          |      |
| 630A   |   |                    |              |              |          |              |          |      |          |      |

 standard article

R = on Request

### Rear mounting



**3L3**



**3N3**



**3L4**

### ON-OFF switch 3 pole with padlockable handle

| <br><b>00G3</b> |  | Rated nom. current | Part no.     | Pack | Part no.     | Pack | Part no.     | Pack |
|-----------------|--|--------------------|--------------|------|--------------|------|--------------|------|
|                 |  | 50A                | CA05000G33L3 | 1    | CA05000G33N3 | R    |              |      |
|                 |  | 63A                | CA06300G33L3 | 1    | CA06300G33N3 | R    |              |      |
|                 |  | 100A               |              |      |              |      | CA10000G33L4 | R    |
|                 |  | 200A               |              |      |              |      | CA20000G33L4 | R    |

### ON-OFF switch 4 pole with padlockable handle

| <br><b>00G4</b> |  | Rated nom. current | Part no.     | Pack | Part no.     | Pack | Part no.     | Pack |
|-----------------|--|--------------------|--------------|------|--------------|------|--------------|------|
|                 |  | 50A                | CA05000G43L3 | 1    | CA05000G43N3 | R    |              |      |
|                 |  | 63A                | CA06300G43L3 | 1    |              |      |              |      |
|                 |  | 100A               |              |      |              |      | CA10000G43L4 | R    |
|                 |  | 200A               |              |      |              |      | CA20000G43L4 | R    |

### Base mounting



**LE3**



**LN3**



**LE4**

### ON-OFF switch 3 pole with padlockable handle

| <br><b>00G3</b> |  | Rated nom. current | Part no.     | Pack | Part no.     | Pack | Part no.     | Pack |
|-----------------|--|--------------------|--------------|------|--------------|------|--------------|------|
|                 |  | 50A                | CA05000G3LE3 | 1    | CA05000G3LN3 | R    |              |      |
|                 |  | 63A                | CA06300G3LE3 | 1    | CA06300G3LN3 | R    |              |      |
|                 |  | 100A               |              |      |              |      | CA10000G3LE4 | 1    |
|                 |  | 200A               |              |      |              |      | CA20000G3LE4 | 1    |

### ON-OFF switch 4 pole with padlockable handle



| <br><b>00G4</b> |  | Rated nom. current | Part no.     | Pack | Part no.     | Pack | Part no.     | Pack |
|-----------------|--|--------------------|--------------|------|--------------|------|--------------|------|
|                 |  | 50A                | CA05000G4LE3 | 1    | CA05000G4LN3 | R    |              |      |
|                 |  | 63A                | CA06300G4LE3 | 1    | CA06300G4LN3 | R    |              |      |
|                 |  | 100A               |              |      |              |      | CA10000G4LE4 | 1    |
|                 |  | 200A               |              |      |              |      | CA20000G4LE4 | 1    |

standard article

R = on Request

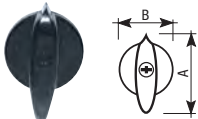

■ Plates and knobs

|   | Part no.  | Description   | Legend included    |            | Pack |
|---|-----------|---|--------------------|------------|------|
|   |           |   | Type               | Degrees    |      |
|   | FINPL3Q7  | Rear mounting with screws, transparent plate 105x105mm (4.13x4.13"), black knob, IP40                       | 0 - 1<br>1 - 0 - 2 | 60°<br>60° | 5    |
|   | FINPL4Q10 | Rear mounting with screws, transparent plate 105x105mm (5.12x5.12"), black knob, IP40                       | 0 - 1<br>1 - 0 - 2 | 60°<br>60° | R    |
|  | FIN3L3Q7  | Rear mounting with screws, yellow plate 105x105mm (4.13x4.13"), red padlockable knob (max 3 padlocks), IP40 | 0 - 1              | 90°        | 5    |
|    | M9G034N5  | black knob square section 10mm (0.39") 105x75 (4.13x2.95")  | -                  | -          | 5    |

■ Flexible PVC protections IP40

|   | Part no.    | Description                               | Dimensions in mm (in) |           | Pack |
|---|-------------|---|-----------------------|-----------|------|
|   |             |   | L                     | Ø         |      |
|  | PROT2271003 | CA050 up to 5 stages CA063 up to 4 stages | 155 (6.10)            | 84 (3.31) | 2    |

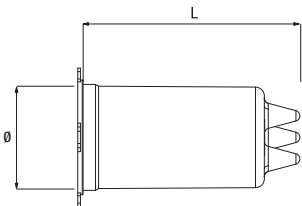
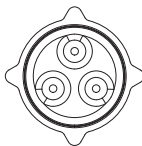
■ Terminals covers for diagrams 00G3,00G4

|   | Part no.       | Description               | Pack |
|---|----------------|---------------------------|------|
|  | PROTLEG3229001 | terminals cover CA050     | 2    |
|   | PROTLEG3229002 | terminals cover CA063     | 2    |
|   | PROTLEG3942    | terminals cover CA100-200 | 2    |

■ Shaft extensions with coupling

|  | Part no.    | Description                                | Pack |
|--|-------------|--|------|
|  | PALBL185    | CA050-063, L.185mm (7.28"), □ 7mm (0.28")  | 10   |
|  | PALBL180Q10 | CA100-063, L.185mm (7.28"), □ 10mm (0.39") | R    |

 standard article

R = on Request

# CA Series - Dimensions

## ■ Base mounting - Handles LE/LN

(switching angle 90°, padlockable with max 3 padlocks)

Measures in mm (in)

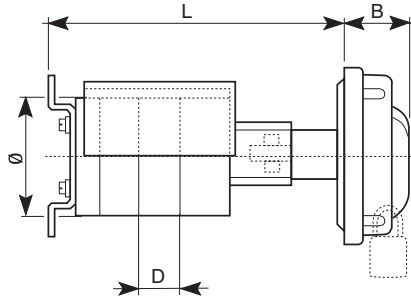

|         | B    |      |
|---------|------|------|
|         | (mm) | (in) |
| LE3-LN3 | 44   | 1.73 |
| LE4-LN4 | 62   | 2.44 |

| Stages no | 2      |             |
|-----------|--------|-------------|
| CA 050    |        |             |
| D = 18    | L (mm) | 135 - 139   |
| 0.71      | L (in) | 5.31 - 5.47 |
| Ø = 74    |        |             |
| 2.91      |        |             |
| CA 063    |        |             |
| D = 25    | L (mm) | 151 - 155   |
| 0.98      | L (in) | 5.94 - 6.10 |
| Ø = 84    |        |             |
| 3.31      |        |             |

| Stages no | 2      |             |
|-----------|--------|-------------|
| CA 100    |        |             |
| D = 30    | L (mm) | 182 - 186   |
| 1.18      | L (in) | 7.16 - 7.32 |
| Ø = 110   |        |             |
| 4.33      |        |             |
| CA 200    |        |             |
| D = 39    | L (mm) | 200 - 204   |
| 1.54      | L (in) | 7.87 - 8.03 |
| Ø = 110   |        |             |
| 4.33      |        |             |

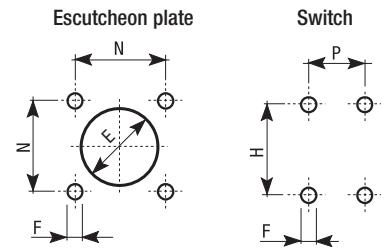

### Dimensions

| handle  | N         | E    | F    | H         | P         |
|---------|-----------|------|------|-----------|-----------|
| LE3/LN3 | 65÷85     | 40   | 5,3  | 84        | 26        |
|         | 2.56÷3.35 | 1.57 | 0.21 | 3.30      | 1.02      |
| LE4/LN4 | 94÷110    | 50   | 5,3  | 94÷110    | 94÷110    |
|         | 3.70÷4.33 | 1.97 | 0.21 | 3.70÷4.33 | 3.70÷4.33 |

## ■ Rear mounting - Handles PL 3L/3N

Measures in mm (in)

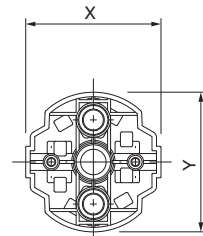
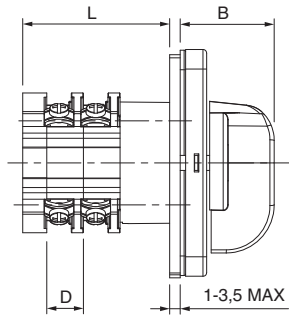

| Series | X | Y         | D       | L | no. of stages |         |         |         |         |          |
|--------|---|-----------|---------|---|---------------|---------|---------|---------|---------|----------|
|        |   |           |         |   | 1             | 2       | 3       | 4       | 5       | 6        |
| CA 050 | - | Ø 74      | 18      | L | 52,5          | 70,5    | 88,5    | 106,5   | 125     | 142,5    |
|        | - | Ø (2,91") | (0,71") |   | (2,07")       | (2,78") | (3,48") | (4,19") | (4,92") | (5,61")  |
| CA 063 | - | Ø 84      | 25      | L | 60,5          | 85,5    | 110,5   | 135,5   | 160,5   | 185,5    |
|        | - | Ø (3,31") | (0,98") |   | (2,38")       | (3,37") | (4,35") | (5,33") | (6,32") | (7,30")  |
| CA 100 | - | Ø 110     | 30      | L | 80,8          | 110,8   | 140,8   | 170,8   | 200,8   | 230,8    |
|        | - | Ø (4,33") | (1,18") |   | (3,18")       | (4,36") | (5,54") | (6,72") | (7,91") | (9,09")  |
| CA 200 | - | Ø 110     | 39      | L | 90            | 129     | 168     | 207     | 246     | 285      |
|        | - | Ø (4,33") | (1,54") |   | (3,54")       | (5,08") | (6,61") | (8,15") | (9,69") | (11,22") |

| Handle  | B          |
|---------|------------|
| PL3     | 44 (1,73") |
| PL4     | 62 (2,44") |
| PL5     | 63 (2,48") |
| PL9     | 73 (2,87") |
| 3N3-3L3 | 44 (1,73") |
| RL6-RK6 | 39 (1,54") |

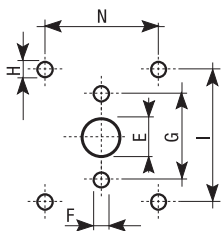

### Dimensions

| cod.    | E  | F    | G   | H    | I   | N    |
|---------|----|------|-----|------|-----|------|
| PL3     | 14 | 0.55 | 5,3 | 0.21 | 40  | 1.57 |
| PL4     | 18 | 0.71 |     |      | 5,3 | 0.21 |
| PL5     | 18 | 0.71 |     |      | 5,3 | 0.21 |
| 3L3/3N3 | 14 | 0.55 | 5,3 | 0.21 | 40  | 1.57 |
| 3L4/3N4 | 18 | 0.71 |     |      | 5,3 | 0.21 |