 TECHNICAL DATA SHEET

ABB cable glands – ST Star Teck® series

Industrial applications



ST - the original STAR TECK® fitting for Teck, MC and ACWU - its innovative design provides quality engineering, easier installation and helps achieve safer, more reliable terminations in challenging industrial environments.

Certifications / Standards:

Features & Benefits:

- Excellent pullout strength
- Robust metallic construction
- Quick and easy installation without disassembly
- “Pop-on” fitting (no dis-assembly) saves installer time
- Provides grounding continuity of cable armor
- Splined gland and gripping features for ease of installation

Applications:

- Provides means for passing jacketed metal clad cables through a bulkhead or enclosure in industrial and hazardous areas
- Oil and gas Industry, chemical and industrial markets
- Construction and installation zones where metal clad cables are specified
- Suitable for cable types:
 - Jacketed Teck and ACWU
 - Armored control and instrument (ACIC)
 - Type MC:
 - Jacketed interlocking armor (aluminum and steel)
 - Jacketed corrugated metal clad (aluminum and steel)

Material:

- Copper free aluminum
- Zinc plated steel option
- Stainless steel option

Environmental ratings:
Working Temperature:

- Normal use -40 to +90°C (-40 to +194°F)

Ingress protection:

- Type 4 / 4X

Chemical resistance guide:

- See publication TDS000081

Conforms to:

- CSA E60079-0/-7
 - Ex e II
- CSA C22.2 No.25/-174
 - Class I Div1 ABCD Class II Div1 EFG Class III Div1
 - Refer to CEC for specific applications
- UL2279
 - Class I, Zone 1, AEx e II
- UL514B/50 and CSA C22.2-18.3/-94
 - Wet and Dry Locations
 - Suitable for Class I Div 2, Class II Div 2 and Class III location per NEC
- RoHS (Restriction of Hazardous Substances Directive) 2011/65/EU Incorporating 2015/863 amendment to Annex II

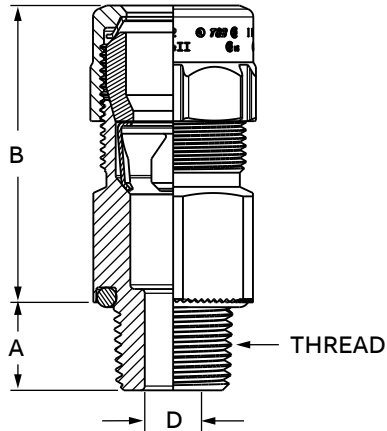
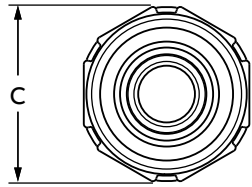
Product selection

Part no:	Thread (NPT)	Range over jacket		Range over armour		Nominal dimensions			
		Min	Max	Min	Max	A	B	C	D
ST038-461S*	3/8	8.74 (0.344)	13.59 (0.535)	6.20 (0.244)	11.05 (0.435)	11.68 (0.460)	51.31 (2.020)	25.27 (0.995)	8.74 (0.344)
ST050-462	1/2	13.34 (0.525)	16.51 (0.650)	10.54 (0.415)	14.48 (0.570)	15.75 (0.620)	51.31 (2.020)	34.13 (1.344)	9.91 (0.390)
ST050-464	1/2	15.24 (0.600)	19.30 (0.760)	12.45 (0.490)	17.27 (0.680)	15.75 (0.620)	51.31 (2.020)	34.13 (1.344)	12.19 (0.480)
ST050-465	1/2	18.42 (0.725)	22.48 (0.885)	15.62 (0.615)	20.45 (0.805)	15.75 (0.620)	54.10 (2.130)	42.07 (1.656)	15.42 (0.607)
ST050-466	1/2	20.96 (0.825)	25.02 (0.985)	18.16 (0.715)	22.99 (0.905)	15.75 (0.620)	54.10 (2.130)	42.07 (1.656)	15.42 (0.607)
ST075-467	3/4	22.35 (0.880)	27.05 (1.065)	19.56 (0.770)	25.02 (0.985)	16.00 (0.630)	62.23 (2.450)	53.18 (2.094)	20.55 (0.809)
ST075-468	3/4	26.04 (1.025)	30.61 (1.205)	23.24 (0.915)	28.58 (1.125)	16.00 (0.630)	62.23 (2.450)	53.18 (2.094)	20.55 (0.809)
ST100-469	1	30.15 (1.187)	34.93 (1.375)	27.36 (1.077)	32.89 (1.295)	19.94 (0.785)	66.04 (2.600)	61.91 (2.438)	26.26 (1.034)
ST125-470	1-1/4	34.29 (1.350)	41.28 (1.625)	31.50 (1.240)	39.24 (1.545)	20.57 (0.810)	83.31 (3.280)	76.20 (3.000)	29.90 (1.177)
ST125-550	1-1/4	38.10 (1.500)	41.28 (1.625)	35.31 (1.390)	39.24 (1.545)	20.57 (0.810)	83.31 (3.280)	76.20 (3.000)	34.67 (1.365)
ST125-471	1-1/4	40.64 (1.600)	47.63 (1.875)	37.85 (1.490)	45.59 (1.795)	20.57 (0.810)	83.31 (3.280)	76.20 (3.000)	34.67 (1.365)
ST150-472	1-1/2	43.18 (1.700)	49.91 (1.965)	40.39 (1.590)	47.88 (1.885)	20.96 (0.825)	91.95 (3.620)	87.31 (3.438)	39.42 (1.552)
ST150-473	1-1/2	48.26 (1.900)	55.55 (2.187)	45.47 (1.790)	53.52 (2.107)	20.96 (0.825)	91.95 (3.620)	87.31 (3.438)	40.51 (1.595)
ST200-551	2	48.26 (1.900)	55.55 (2.187)	45.47 (1.790)	53.52 (2.107)	21.84 (0.860)	92.46 (3.640)	96.84 (3.813)	43.43 (1.710)
ST200-474	2	53.34 (2.100)	60.33 (2.375)	50.55 (1.990)	57.91 (2.280)	21.84 (0.860)	92.46 (3.640)	96.84 (3.813)	50.55 (1.990)
ST200-475	2	58.42 (2.300)	65.15 (2.565)	55.63 (2.190)	63.12 (2.485)	21.84 (0.860)	92.46 (3.640)	106.36 (4.188)	52.12 (2.052)
ST200-476	2	63.50 (2.500)	69.85 (2.750)	60.71 (2.390)	67.46 (2.656)	21.84 (0.860)	92.46 (3.640)	106.36 (4.188)	52.12 (2.052)
ST250-477	2-1/2	60.45 (2.380)	67.06 (2.640)	56.90 (2.240)	65.02 (2.560)	32.51 (1.280)	119.38 (4.700)	121.44 (4.781)	57.28 (2.255)

*This product is not CSA certified or UL listed.

Bold numbers are metric, parenthesis numbers are inches.

To order steel version, add suffix "S". Ex: ST050-464S

Stainless steel available from 1/2" to 3". Add suffix "SS". Ex: ST050-464SS

To order with PVC coating, add suffix "PVC". Ex: ST050-464SPVC. Available for aluminum and steel constructions.

Contact your representative for availability

Dimensions may vary depending on material selection.

Note: Product must be installed in accordance with applicable national and local electrical codes.

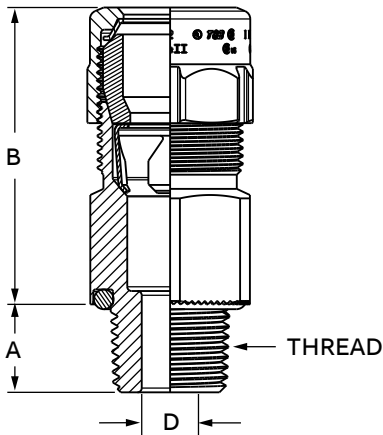
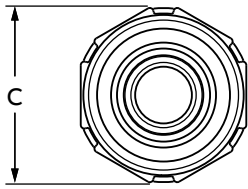

Product selection

Part no:	Thread (NPT)	Range over jacket		Range over armour		Nominal dimensions			
		Min	Max	Min	Max	A	B	C	D
ST250-478	2-1/2	65.53	72.14	61.98	69.85	32.51	119.38	121.44	62.36
		(2.580)	(2.840)	(2.440)	(2.750)	(1.280)	(4.700)	(4.781)	(2.455)
ST300-479	3	70.87	77.72	67.06	75.44	34.04	119.38	129.38	67.44
		(2.790)	(3.060)	(2.640)	(2.970)	(1.340)	(4.700)	(5.094)	(2.655)
ST300-480	3	76.20	83.06	72.90	81.03	34.04	121.67	139.70	73.28
		(3.000)	(3.270)	(2.870)	(3.190)	(1.340)	(4.790)	(5.500)	(2.885)
ST300-481	3	81.53	88.39	77.27	86.11	34.04	121.67	139.70	77.65
		(3.210)	(3.480)	(3.042)	(3.390)	(1.340)	(4.790)	(5.500)	(3.057)
ST350-482	3-1/2	86.87	93.73	83.06	91.19	35.31	121.67	153.19	83.44
		(3.420)	(3.690)	(3.270)	(3.590)	(1.390)	(4.790)	(6.031)	(3.285)
ST350-483	3-1/2	91.69	98.30	87.38	95.76	35.31	121.67	153.19	87.76
		(3.610)	(3.870)	(3.440)	(3.770)	(1.390)	(4.790)	(6.031)	(3.455)
ST400-484	4	96.77	102.36	91.44	99.82	36.58	122.94	166.69	92.08
		(3.810)	(4.030)	(3.600)	(3.930)	(1.440)	(4.840)	(6.563)	(3.625)
ST400-485	4	100.71	106.30	95.38	103.25	36.58	122.94	166.69	95.76
		(3.965)	(4.185)	(3.755)	(4.065)	(1.440)	(4.840)	(6.563)	(3.770)
ST400-486	4	104.65	110.24	99.31	107.19	36.58	122.94	166.69	99.95
		(4.120)	(4.340)	(3.910)	(4.220)	(1.440)	(4.840)	(6.563)	(3.935)

*This product is not CSA certified or UL listed.

Bold numbers are metric, parenthesis numbers are inches.

To order steel version, add suffix "S". Ex: ST050-464S

Stainless steel available from 1/2" to 3". Add suffix "SS". Ex: ST050-464SS

To order with PVC coating, add suffix "PVC". Ex: ST050-464SPVC. Available for aluminum and steel constructions.

Contact your representative for availability

Dimensions may vary depending on material selection.

Note: Product must be installed in accordance with applicable national and local electrical codes.

