

8.1 - TUERCA UNION DE ALUMINIO. PARA AREAS PELIGROSAS. SERIE TU.

8.1 - ALUMINUM CONDUIT UNION. FOR HAZARDOUS LOCATIONS. TU SERIES.

FICHA TECNICA / TECHNICAL DATA

007 - RW - 227

APLICACIONES:

- Utilizados para unir tubo conduit y accesorios, permitiendo desmontar sin desenroscar el tubo.

CONSTRUCCION:

- Aluminio libre de cobre inyectado a presión (diecast).
- Ranuras concéntricas de empuje para asegurar un sellado perfecto.
- Rosca NPT para usarse con tubo conduit RIGIDO.
- Roscas de precisión para garantizar continuidad en el aterrizaje.

ACABADOS:

- Pintura electrostática epoxica/poliéster polimerizado.

Clase I, Div. 1 & 2, grupos C, D.

Clase II, Div. 1, grupos E, F, G.

Clase II, Div. 2, grupos F, G.

Clase III.

NEMA 4, 4X, 7 C D, 9 E F G.

- Fabricación en base a: UL 886, UL 1203
CAN/CSA - C22.2 No. 30

APPLICATIONS:

- Conduit unions are used to connect conduit to conduit fittings, allowing to disassembly it, without turning the conduit.

CONSTRUCTION:

- Diecast copper free aluminum.
- Matching grooves to have a perfect seal.
- NPT threaded for use with RIGID conduit.
- Precision threads to assure ground continuity.

FINISH:

- Electrostatic powder epoxy/poliéster coating.

Class I, Div. 1 & 2, groups C, D.

Class II, Div. 1, groups E, F, G.

Class II, Div. 2, groups F, G.

Class III.

NEMA 4, 4X, 7 C D, 9 E F G.

- Manufactured in compliance with: UL 886, UL 1203
CAN/CSA - C22.2 No. 30

Para dimensiones:
Ver Ficha Técnica 007-RW-262
For dimensions:
See Technical Data 007-RW-262

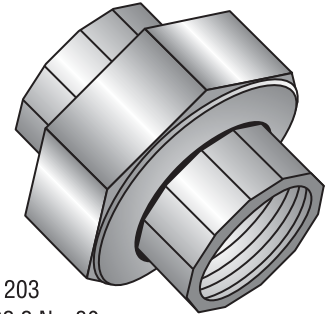

TUERCA UNION HEMBRA / FEMALE CONDUIT UNION

USAR No. DE CODIGO PARA HACER PEDIDOS / TO ORDER USE CODE NUMBER

Figura Figure	Catálogo Catalog	Código Code	Medida Nominal Size		Peso x 100 pzas. Weight x 100 pcs.		Unit Ctn. Pzas. Pcs.	Ship Ctn. Pzas. Pcs.	Std. Pkg. Pzas. Pcs.
			mm	inch	kg	Lb			
	TU-2992	12.28.2992	12.7	1/2	8.75	19.29			84
	TU-2993	12.28.2993	19.0	3/4	11.00	24.20			78
	TU-2994	12.28.2994	25.4	1	13.50	29.76			80
	TU-2995	12.28.2995	31.7	1 1/4	21.20	46.74			70
	TU-2996	12.28.2996	38.1	1 1/2	22.70	50.05			55
	TU-2997	12.28.2997	50.8	2	45.00	99.00			27

TUERCA UNION MACHO - HEMBRA / MALE - FEMALE CONDUIT UNION

USAR No. DE CODIGO PARA HACER PEDIDOS / TO ORDER USE CODE NUMBER

Figura Figure	Catálogo Catalog	Código Code	Medida Nominal Size		Peso x 100 pzas. Weight x 100 pcs.		Unit Ctn. Pzas. Pcs.	Ship Ctn. Pzas. Pcs.	Std. Pkg. Pzas. Pcs.
			mm	inch	kg	Lb			
	TU-2992-N	12.28.3149.N	12.7	1/2	11.75	26.00			80
	TU-2993-N	12.28.3150.N	19.0	3/4	14.00	31.00			60
	TU-2994-N	12.28.3151.N	25.4	1	22.50	49.00			80
	TU-2995-N	12.28.3152.N	31.7	1 1/4	31.00	68.00			70
	TU-2996-N	12.28.3153.N	38.1	1 1/2	37.00	81.00			55
	TU-2997-N	12.28.3154.N	50.8	2	64.00	141.00			27

Especificaciones sujetas a cambio sin previo aviso.

Specifications are subject to change without notice.

RAWELT, S.A. de C.V.

RAWELT ® INYECTADOS
Una División del Grupo **REVUELTA**

8.1 - TUERCA UNION DE ALUMINIO. PARA AREAS PELIGROSAS. SERIE TU.

Hoja: 2 / 2
Page:

8.1 - ALUMINUM CONDUIT UNION. FOR HAZARDOUS LOCATIONS. TU SERIES.

FICHA TECNICA / TECHNICAL DATA

007-RW-227

NIPLES / NIPPLES

USAR No. DE CODIGO PARA HACER PEDIDOS / TO ORDER USE CODE NUMBER

Figura Figure	Catálogo Catalog	Código Code	Medida nominal Hub size			Peso x 100 pzas. Weight x 100 pcs.		Pqt. Unit. Pzas. Pcs.	Unit Ctn. Pzas. Pcs.	Ship Ctn. Pzas. Pcs.	Std. Pkg. Pzas. Pcs.
			mm	inch.		kg	Lb				
			 NIPLE	NI-13		04.21.2576	12.7				
NI-19	04.21.2577	19.0		3/4			25				
NI-25	04.21.2573	25.4		1			25				
NI-32	04.21.3233	31.7		1 1/4			10				
NI-38	04.21.3234	38.1		1 1/2			10				
NI-50	04.21.3235	50.8		2			10				

Certificaciones / Compliances:  Expediente/File No. E198859

Certificaciones / Compliances:  Expediente/File No. 1187341

Class I groups A, B, C and D; **Class II** groups E, F and G; **Class III**
TU-2992, TU-2993

Class I groups B, C and D; **Class II** groups E, F and G; **Class III**
TU-2997

Class I groups C and D; **Class II** groups E, F and G; **Class III**
TU-2996

RAWELT, S.A. de C.V.

RAWELT® INYECTADOS
Una División del Grupo **REVUELTA**

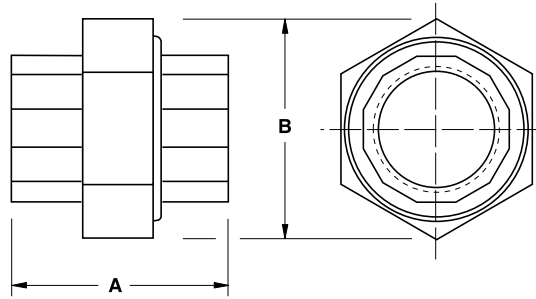

TUERCA UNION HEMBRA				FEMALE CONDUIT UNION			
Catalogo Catalog	Código Code	Medida Nominal Size		Longitud Length		Medida ext. Máx. Max. Outside size	
		mm	Inch.	A		B	
				mm	Inch.	mm	Inch.
TU-2992	12.28.2992	12.7	1/2	44	1.73	51	2.00
TU-2993	12.28.2993	19.0	3/4	44	1.73	56	2.20
TU-2994	12.28.2994	25.4	1	52	2.04	62	2.44
TU-2995	12.28.2995	31.7	1 1/4	58	2.20	77	3.03
TU-2996	12.28.2996	38.1	1 1/2	61	2.38	83	3.27
TU-2997	12.28.2997	50.8	2	70	2.77	103	4.06

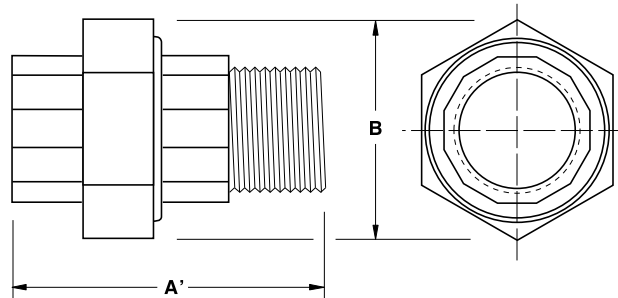

TUERCA UNION MACHO-HEMERA				MALE-FEMALE CONDUIT UNION			
Catalogo Catalog	Código Code	Medida Nominal Size		Longitud Length		Medida ext. Máx. Max. Outside size	
		mm	Inch.	A'		B	
				mm	Inch.	mm	Inch.
TU-2992-N	12.28.3149.N	12.7	1/2	77	3.03	51	2.00
TU-2993-N	12.28.3150.N	19.0	3/4	77	3.03	56	2.20
TU-2994-N	12.28.3151.N	25.4	1	91	3.58	62	2.44
TU-2995-N	12.28.3152.N	31.7	1 1/4	99	3.90	77	3.03
TU-2996-N	12.28.3153.N	38.1	1 1/2	106	4.17	83	3.27
TU-2997-N	12.28.3154.N	50.8	2	118	4.65	103	4.06

Cotización/Quotation Plazo de embarque* / Shipment exw* :

 Pedido No./Purchase order : _____

Our ref.: _____

Fecha/Date: _____ Vendedor/Salesman: _____ No. _____

Facturar a/Invoice to: _____ RFC: _____

Ordenado por/Ordered by: _____ Tel. () _____ Fax () _____

Dirección/Address: _____

_____ C.P./Zip: _____ Lugar/City/Country: _____

Consignar a/Ship to: _____

 _____ Embarcar: Camión x Cobrar Pagado Paquete

Cond. de Pago/Terms: _____

Cond. de Venta/Sale conditions: _____ L.P.: _____

8.1 - SERIE TU. TUERCA UNION DE ALUMINIO. HEMBRA / ALUMINUM FEMALE CONDUIT UNION.

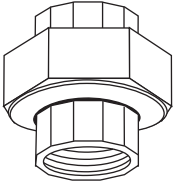
Figura Figure	Código Code	Medida nominal Hub size		Pqt. Unit. Pzas. Pcs.	Unit. Ctn. Pzas. Pcs.	Ship Ctn. Pzas. Pcs.	Std. Pkg. Pzas. Pcs.	Cantidad Qty.
		mm	inch					
	12.28.2992	12.7	1/2				84	
	12.28.2993	19.0	3/4				78	
	12.28.2994	25.4	1				80	
	12.28.2995	31.7	1 1/4				70	
	12.28.2996	38.1	1 1/2				55	
	12.28.2997	50.8	2				27	

8.1 - SERIE TU. TUERCA UNION DE ALUMINIO. MACHO - HEMBRA / ALUMINUM MALE - FEMALE CONDUIT UNION

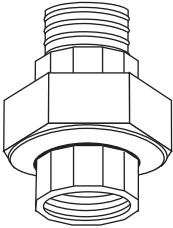
Figura Figure	Código Code	Medida nominal Hub size		Pqt. Unit. Pzas. Pcs.	Unit. Ctn. Pzas. Pcs.	Ship Ctn. Pzas. Pcs.	Std. Pkg. Pzas. Pcs.	Cantidad Qty.
		mm	inch					
	12.28.3149.N	12.7	1/2				80	
	12.28.3150.N	19.0	3/4				60	
	12.28.3151.N	25.4	1				80	
	12.28.3152.N	31.7	1 1/4				70	
	12.28.3153.N	38.1	1 1/2				55	
	12.28.3154.N	50.8	2				27	

	04.21.2576	12.7	1/2	25				
	04.21.2577	19.0	3/4	25				
	04.21.2573	25.4	1	25				
	04.21.3233	31.7	1 1/4	10				
	04.21.3234	38.1	1 1/2	10				
	04.21.3235	50.8	2	10				

• Antes de fincar el pedido en firme, favor de confirmar con fábrica el plazo de embarque definitivo.

• Before place your order, please confirm with RAWELT definitive date of shipment.

 Producción Almacén Embarques Control Expediente

Cliente

Ing. de Ventas